



**Calhoun: The NPS Institutional Archive**  
**DSpace Repository**

---

Theses and Dissertations

1. Thesis and Dissertation Collection, all items

---

1996-12

# Reengineering the Navy Program Objectives Memorandum (POM) process

Simcik, Thomas A.

Monterey, California. Naval Postgraduate School

---

<http://hdl.handle.net/10945/32038>

---

*Downloaded from NPS Archive: Calhoun*



Calhoun is the Naval Postgraduate School's public access digital repository for research materials and institutional publications created by the NPS community. Calhoun is named for Professor of Mathematics Guy K. Calhoun, NPS's first appointed -- and published -- scholarly author.

**Dudley Knox Library / Naval Postgraduate School**  
**411 Dyer Road / 1 University Circle**  
**Monterey, California USA 93943**

<http://www.nps.edu/library>

**NAVAL POSTGRADUATE SCHOOL**  
**Monterey, California**



**THESIS**

**REENGINEERING THE NAVY  
PROGRAM OBJECTIVES MEMORANDUM  
(POM) PROCESS**

by

Thomas A. Simcik

December, 1996

Thesis Advisor

L. R. Jones

**Approved for public release; distribution is unlimited.**

DTIC QUALITY INSPECTED 3

19970701 069

# REPORT DOCUMENTATION PAGE

Form Approved OMB No. 0704-0188

Public reporting burden for this collection of information is estimated to average 1 hour per response, including the time for reviewing instruction, searching existing data sources, gathering and maintaining the data needed, and completing and reviewing the collection of information. Send comments regarding this burden estimate or any other aspect of this collection of information, including suggestions for reducing this burden, to Washington Headquarters Services, Directorate for Information Operations and Reports, 1215 Jefferson Davis Highway, Suite 1204, Arlington, VA 22202-4302, and to the Office of Management and Budget, Paperwork Reduction Project (0704-0188) Washington DC 20503.

1. AGENCY USE ONLY <i>(Leave blank)</i>	2. REPORT DATE December 1996	3. REPORT TYPE AND DATES COVERED Master's Thesis	
4. TITLE AND SUBTITLE REENGINEERING THE NAVY PROGRAM OBJECTIVES MEMORANDUM (POM) PROCESS		5. FUNDING NUMBERS	
6. AUTHOR(S) Simcik, Thomas A.		8. PERFORMING ORGANIZATION REPORT NUMBER	
7. PERFORMING ORGANIZATION NAME(S) AND ADDRESS(ES) Naval Postgraduate School Monterey CA 93943-5000		10. SPONSORING/MONITORING AGENCY REPORT NUMBER	
9. SPONSORING/MONITORING AGENCY NAME(S) AND ADDRESS(ES)		11. SUPPLEMENTARY NOTES The views expressed in this thesis are those of the author and do not reflect the official policy or position of the Department of Defense or the U.S. Government.	
12a. DISTRIBUTION/AVAILABILITY STATEMENT Approved for public release; distribution is unlimited.		12b. DISTRIBUTION CODE	
13. ABSTRACT <i>(maximum 200 words)</i> <p>This thesis examines the Navy Planning, Programming and Budgeting System (PPBS) to determine if reengineering principles can be applied to increase the efficiency and effectiveness of resource allocation. In particular it focuses on improving the Program Objectives Memorandum (POM) process. A comprehensive description and analysis of the current Navy PPBS process is provided. This thesis analyzes unique characteristics of the policies, procedures and organizations that have shaped the development of the Navy POM process, as well as the major external forces that have affected Navy PPBS.</p> <p>Process reengineering for the POM is evaluated against criteria represented in three resource allocation methodologies: Strategy-to-Tasks, Mission-Based resource allocation, and the General Staff Command. A description of each methodology is provided along with its application to the Navy POM and PPBS process.</p> <p>Organizational structure and resource allocation processes within DOD have been under constant scrutiny and revision since WWII. This thesis recommends a resource management method that provides for a fundamental redesign of the current PPBS process. Implementation of this methodology would have broad effects on DOD and Navy organizations, the roles and missions of the military departments and services and unified military operations.</p>			
14. SUBJECT TERMS Planning, Programming and Budgeting System, Program Objectives Memorandum, Reengineering		15. NUMBER OF PAGES 130	
		16. PRICE CODE	
17. SECURITY CLASSIFICATION OF REPORT Unclassified	18. SECURITY CLASSIFICATION OF THIS PAGE Unclassified	19. SECURITY CLASSIFICATION OF ABSTRACT Unclassified	20. LIMITATION OF ABSTRACT UL

NSN 7540-01-280-5500

Standard Form 298 (Rev. 2-89)  
Prescribed by ANSI Std. Z39-18 298-102

DTIC QUALITY INSPECTED 3



Approved for public release; distribution is unlimited.

**REENGINEERING THE NAVY  
PROGRAM OBJECTIVES MEMORANDUM (POM)  
PROCESS**

Thomas A. Simcik  
Lieutenant, United States Naval Reserve  
B.A., University of Pittsburgh, 1986

Submitted in partial fulfillment  
of the requirements for the degree of

**MASTER OF SCIENCE IN MANAGEMENT**

from the

**NAVAL POSTGRADUATE SCHOOL  
December 1996**

Author:

[Redacted]

*TS*  
Thomas A. Simcik

Approved by:

[Redacted]

*L.R.J.*  
L.R. Jones, Principal Thesis Advisor

[Redacted]

*J.L.McC.*  
Jerry L. McCaffery, Associate Advisor

[Redacted]

*R.T.H.*  
Reuben T. Harris, Chairman  
Department of Systems Management



## ABSTRACT

This thesis examines the Navy Planning, Programming and Budgeting System (PPBS) to determine if reengineering principles can be applied to increase the efficiency and effectiveness of resource allocation. In particular it focuses on improving the Program Objectives Memorandum (POM) process. A comprehensive description and analysis of the current Navy PPBS process is provided. This thesis analyzes unique characteristics of the policies, procedures and organizations that have shaped the development of the Navy POM process, as well as the major external forces that have affected Navy PPBS.

Process reengineering for the POM is evaluated against criteria represented in three resource allocation methodologies: Strategy-to-Tasks, Mission-Based resource allocation, and the General Staff Command. A description of each methodology is provided along with its application to the Navy POM and PPBS process.

Organizational structure and resource allocation processes within DOD have been under constant scrutiny and revision since WWII. This thesis recommends a resource management method that provides for a fundamental redesign of the current PPBS process. Implementation of this methodology would have broad effects on DOD and Navy organizations, the roles and missions of the military departments and services and unified military operations.





## TABLE OF CONTENTS

I. INTRODUCTION .....	1
A. PURPOSE .....	1
B. BACKGROUND .....	4
C. METHODOLOGY .....	6
II. PLANNING, PROGRAMMING, AND BUDGETING SYSTEM (PPBS) .....	7
A. PPBS OVERVIEW .....	7
B. DEPARTMENT OF THE NAVY (DON) PPBS .....	9
1. Planning Phase .....	10
a. Broad Overview of the Planning Strategy .....	12
(1) Identify National Interests .....	12
(2) Examine World Security Environment .....	12
(3) Define National Military Strategy .....	13
(4) Plan Force Structure .....	14
b. Planning as a Phase of PPBS .....	14
(1) Key Personnel in the Planning Phase .....	15
(2) Framework of the Planning Phase .....	15
(3) Key Planning Documents .....	17
2. Programming Phase .....	22
a. Key Navy Staff .....	22
(1) Resources and Requirements Review Board (R <sup>3</sup> B) .....	23
(2) Resource Sponsor .....	26
(3) Appropriation Sponsor .....	27
(4) Navy Staff Executive Steering Committee (ESC) .....	28
(5) DON Program Strategy Board (DPSB) .....	29
b. Key Navy Programming Documents .....	30
(1) Program Objectives Memorandum (POM) .....	30
(2) Future Years Defense Program (FYDP) .....	30
(3) Resource Allocation Display (RAD) .....	31

c. Programming Sub-phases .....	31
(1) Program Assessment .....	32
(2) POM Development .....	39
(3) POM Delivery and OSD Program Review .....	43
3. Budgeting Phase .....	46
a. Budget Formulation .....	48
b. Budget Presentation and Review .....	50
(1) DON Budget Review .....	50
(2) OSD/OMB Budget Review .....	52
 III. PRINCIPLES OF REENGINEERING .....	 55
A. INTRODUCTION .....	55
B. REENGINEERING DEFINITION .....	57
C. REENGINEERING PRINCIPLES .....	59
D. IMPLEMENTING REENGINEERING .....	63
E. REENGINEERING GOVERNMENT.....	65
F. SUMMARY .....	69
 IV. REENGINEERING THE NAVY POM AND PPBS PROCESSES .....	 71
A. INTRODUCTION .....	71
B. STRATEGY-TO-TASKS .....	74
1. Description .....	74
2. Application to Navy POM and PPBS Processes .....	77
C. MISSION-BASED RESOURCE ALLOCATION .....	79
1. Description .....	79
2. Application to Navy POM and PPBS Processes .....	85
D. GENERAL STAFF COMMAND .....	89
1. Description .....	89
2. Application to Navy POM and PPBS Processes .....	91

V. CONCLUSIONS/RECOMMENDATIONS .....	95
A. CONCLUSIONS .....	95
B. RECOMMENDATIONS .....	98
C. AREAS FOR FURTHER RESEARCH .....	99
APPENDIX A. GENERAL PPBS SCHEDULE.....	101
APPENDIX B. POM-98 NAVY SCHEDULE OF EVENTS.....	103
LIST OF REFERENCES.....	107
INITIAL DISTRIBUTION LIST .....	113



## LIST OF FIGURES

1. CNO Staff Organization.....	2
2. Basic PPBS Process.....	8
3. PPBS Milestones.....	9
4. Navy PPBS Overview.....	11
5. Planning Process Overview.....	15
6. DPRB Members.....	21
7. Resources and Requirements Review Board (R <sup>3</sup> B).....	25
8. R <sup>3</sup> B Executive Panel.....	26
9. Navy Resource Sponsors.....	27
10. Navy Appropriation Sponsors.....	28
11. DPSB Members.....	29
12. Program Planning Sub-phase Overview.....	33
13. Baseline Assessment Area Sponsors.....	35
14. DON JWA/SA Teams.....	38
15. POM Development Sub-phase.....	40
16. POM Delivery and OSD Program Review Sub-phase.....	44
17. Program Review Group (PRG) Membership.....	45
18. OSD Program Review.....	47
19. POM/Budget Comparison.....	49
20. DON Budget Review Schedule.....	52
21. OSD/OMB Budget Review Schedule.....	53
22. Strategy-to-Tasks Hierarchy of Linkages.....	75
23. Mission-Based Program Development .....	88



## LIST OF ACRONYMS

ACNO	Assistant Chief of Naval Operations
ASN	Assistant Secretary of the Navy
BAM	Baseline Assessment Memorandum
BES	Budget Estimate Submission
BGM	Budget Guidance Manual
BPR	Business Process Reengineering
BSO	Budget Submitting Office
CEB	CNO Executive Board
CEP	CNO Executive Panel
CIA	Central Intelligence Agency
CINC	Commander in Chief
CIP	Component Commander Issue Paper
CJCS	Chairman, Joint Chiefs of Staff
CNO	Chief of Naval Operations
CPA	Chairman's Program Assessment
CPR	Chairman's Program Recommendations
DBOF	Defense Business Operations Fund
DCNO	Deputy Chief of Naval Operations
DCS	Deputy Chief of Staff
DEPSECDEF	Deputy Secretary of Defense
DIA	Defense Intelligence Agency
DMRD	Defense Management Report Decision
DOD	Department of Defense
DON	Department of the Navy
DONPG	Department of the Navy Programming Guidance
DPA&E	Director, Program Analysis and Evaluation
DPG	Defense Planning Guidance
DPRB	Defense Planning Resources Board
DPSB	Department of the Navy Program Strategy Board
DSO	Director of Staff Office
ESC	Executive Steering Committee
FMB	Director, Office of Budget
FMC	Financial Management and Comptroller
FY	Fiscal Year
FYDP	Future Years Defense Program

IBR	Investment Balance Review
IDT	Issue Development Team
IP	Issue Paper
IPL	Integrated Priority List
IR3B	Integrated Resources and Requirements Review Board
J-5	Strategic Plans and Policy Directorate
J-8	Force Structure, Resources and Assessment Directorate
JCS	Joint Chiefs of Staff
JMA/SA	Joint Mission Area/Support Area
JMRR	Joint Monthly Readiness Review
JPAM	Joint Program Assessment Memorandum
JROC	Joint Requirements Oversight Committee
JSPD	Joint Strategic Planning Document
JSPS	Joint Strategic Planning System
JSR	Joint Strategy Review
JWCA	Joint Warfare Capabilities Assessment
MBI	Major Budget Issue
MOE	Measure of Effectiveness
MRC	Major Regional Conflict
N51	Director, Strategy and Policy Division
N8	DCNO (Resources, Warfare Requirements and Assessment)
N80	Director, Programming Division
N81	Director, Assessment Division
N82	Director, Fiscal Management Division
N83	Director, CINC Liaison Division
N85	Director, Expeditionary Warfare Division
N86	ACNO (Surface Warfare)
N87	ACNO (Submarine Warfare)
N88	Director, Air Warfare
NAVCOMPT	Navy Comptroller
NCA	National Command Authority
NMS	National Military Strategy
NMSD	National Military Strategy Document
NPR	National Performance Review
NSS	National Security Strategy
OASD	Office of the Assistant Secretary of Defense



OMB	Office of Management and Budget
OPA	Office of Program Appraisal
OPNAV	Office of the Chief of Naval Operations
OSD	Office of the Secretary of Defense
PBD	Program Budget Decision
PDM	Program Decision Memorandum
PDRC	Program Development Review Committee
PE	Program Element
PL	Public Law
POM	Program Objectives Memorandum
PPBS	Planning, Programming and Budgeting System
PPG	Preliminary Programming Guidance
PRC	Program Review Committee
PRG	Program Review Group
R3B	Resources and Requirements Review Board
RAD	Resource Allocation Display
RS	Resource Sponsor
SAG	Sub-Activity Group
SECDEF	Secretary of Defense
SECNAV	Secretary of the Navy
SPP	Sponsor Program Proposal
SPPD	Sponsor Program Proposal Document
TOA	Total Obligational Authority
TPOM	Tentative POM
TQM	Total Quality Management
USD(P)	Under Secretary of Defense for Policy
VCJCS	Vice Chairman, Joint Chiefs of Staff
VCNO	Vice Chief of Naval Operations
ZOW	Zumwalt's Own Words

## I. INTRODUCTION

### A. PURPOSE

The purpose of this thesis is to examine the Navy Planning, Programming and Budgeting System (PPBS) to determine if *reengineering* principles can be applied to increase the efficiency and effectiveness of resource allocation. In particular it will focus on improving the Program Objectives Memorandum (POM) process in the Programming phase of PPBS. The thesis concludes that central to this improvement is the implementation of reengineering and *mission-based budgeting* tenets in requirements, programs and financial decision-making.

To recommend improvements to the PPBS it is first necessary to develop an accurate description of the current process. This thesis will attempt to provide such a description. It also will analyze the unique characteristics of Navy policies, procedures and organizations that have shaped development of the Navy POM process, as well as, the major external forces that have affected Navy PPBS.

In October 1992, the Chief of Naval Operations reorganized the Navy headquarters staff (OPNAV). The three major resource sponsors (submarine, surface, and air) were consolidated under a single "Navy voice" for program direction—the Deputy Chief of Naval Operations for Resources, Warfare Requirements, and Assessment (N8). Prior to the reorganization, resource sponsors focused mainly on their roles as platform and warfare community advocates. Now a streamlined assessment process, premised on the

elimination of barriers among individual naval warfare communities and the services, has the benefit of expertise from all Navy and Marine Corps platforms and warfare disciplines to reach the best overall decision from both a Naval Service and joint service viewpoint. (Ref. 1, pp. 44-46) The OPNAV reorganization was implemented to end the traditional "warfare barons" and unproductive parochialism that characterized previous resource allocation decisions. **Figure (1)** illustrates the new OPNAV organization.

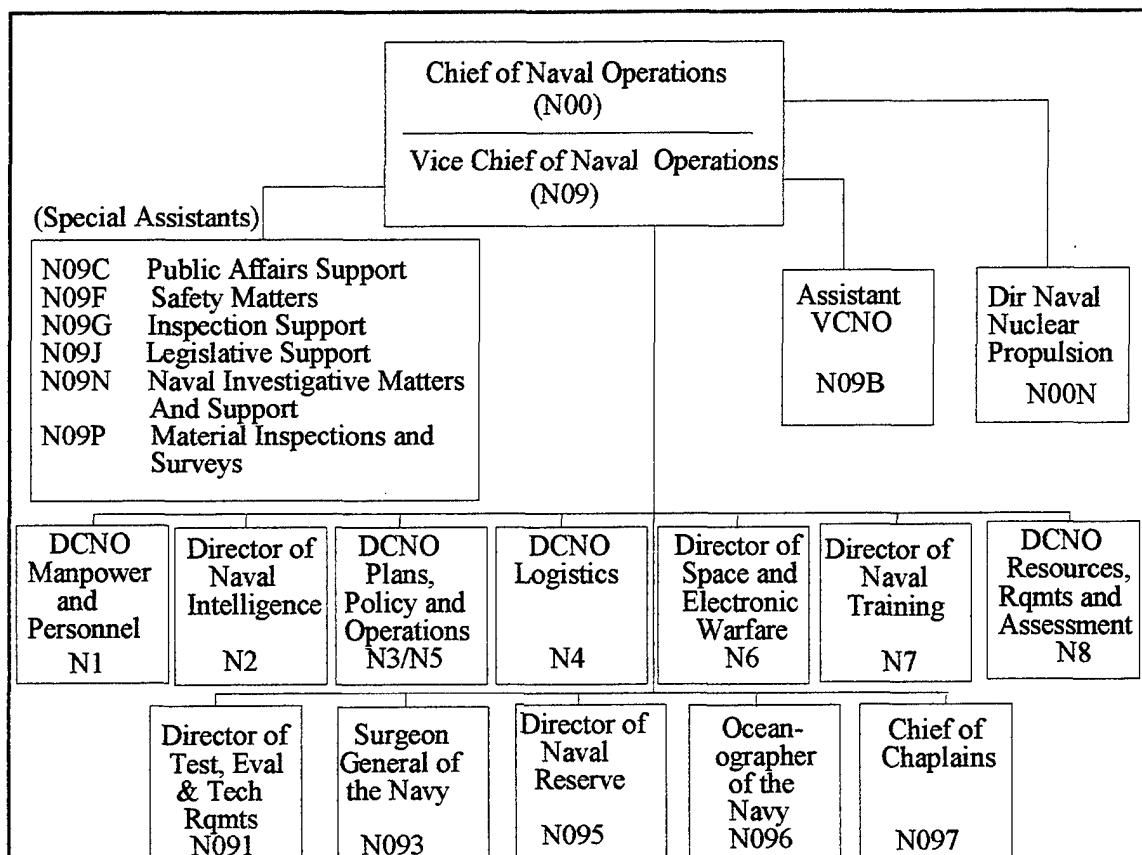

**Figure 1** CNO Staff Organization

This new assessment/planning process takes place under the purview of Joint Mission Area/Support Area (JMA/SA) Assessments. The JMA/SA was designed to give a larger role to program planning during the Navy's PPBS. Additionally, establishment of the Resources and Requirements Review Board (R<sup>3</sup>B) in January 1993 by Vice Admiral William Owens (the first N8), with approval of the CNO, further streamlined the resource allocation process by disbanding ten formal headquarters boards. Now a three-tier committee review constitutes the Naval Service senior program and policy decision process (Ref. 1, p. 47). The R<sup>3</sup>B serves as the focal point for assessing joint warfare mission and support areas of the Navy, determining warfare requirements and resource issues, and coordinating the planning, programming and budgeting process.

Program and policy issues are continuously encountered in the Navy that affect the budget and the POM. It may be argued that a better, more symbiotic, relationship between programmers and budgeters should be developed. The Navy's current structure of a centralized planning and programming development process and decentralized budget development/execution may result in a variety of resource decision problems for the Navy.

This thesis will attempt to provide a basis for a fundamental rethinking and possible reengineering of Navy programming and budgeting processes, perhaps similar in some ways to the OPNAV reorganization of 1992 and the establishment of the Resources and Requirements Review Board in 1993. It will focus on streamlining, eliminating redundancies and the overlap of processes to

ensure the most efficient and effective organization with special emphasis to the programming phase and budget formulation phase. The goal of the thesis is to determine if PPBS process change is desirable and feasible while maintaining decision and process consistency and creating a smoother transition from Program Objective Memorandum to Budget Estimates Submission.

## **B. BACKGROUND**

The purpose of the Planning, Programming and Budgeting System within the Department of the Navy (DON) is to obtain and provide the necessary Navy and Marine Corps forces and the associated resources to meet national military objectives. To ensure maximum effectiveness in obtaining needed forces and resources, it is the policy of the Secretary and Department of the Navy to decentralize programming and budgeting tasks while providing centralized policy guidance. It is assumed that involvement in program and budget formulation of organizations responsible for program and budget execution leads to the most effective combination of programs and resources for the Navy and Marine Corps, and results in a budget that allows execution to proceed effectively. (Ref. 2, p. 1)

The current PPBS structure of the Navy should be examined to determine if it meets the goals that it advocates. Additionally, it should be examined to determine if it is the most efficient and effective method for the complex task of resource allocation with the Department of the Navy.

Program budgeting arose out of concern for the perceived deficiencies of traditional line-item budgeting. These deficiencies included:

- The short-term focus of the budget.
- The incremental nature and historical bias of the process and its outcomes.
- The emphasis on organizational inputs rather than program outputs.
- The excessive detail in budget documents.
- The lack of relationship with government objectives.
- The failure to provide a means of examining alternative methods for accomplishing objectives.
- The failure to identify duplication of effort. (Ref. 3)

In contrast to traditional budgeting, program budgeting is intended to provide a rational framework for decision-making to improve efficiency in the allocation of resources. The strengths of PPBS include:

- A long-range planning perspective.
- An emphasis on both quantitative and qualitative analysis at all stages of activity.
- The use of aggregate data rather than line-item detail.
- The use of program structures rather than organizational structures.
- A basis for choosing between available and feasible alternatives for achieving objectives. (Ref. 4)

Programming resource requirements for the outyears includes analyzing past, present and future resource requirements of Navy organizations and programs. Historical and current cost data are not readily available to the Programming divisions and Budget Formulation personnel do not actively participate in the POM formulation. Programmers are not involved in oversight of day-to-day operations of Navy organizations so they must depend on field activity budget personnel for cost projections. Extensive coordination between

the programmers and budgeters is required to ensure maximum utilization of available human and data resources. Intimate knowledge of how dollars are executed by organizational units could lessen the confusion, increase productivity and enhance efficiency in programming. Historically, programmers have reviewed programs almost unconstrained by resources, and budgeters have reviewed the need more closely for dollars in a specific year. A combination of the two is necessary to more effectively allocate Navy resources in competition with the other military departments and services.

### **C. METHODOLOGY**

The methodology utilized in this study will include research into all applicable PPBS directives, instructions and publications from the Department of Defense (DOD) and Department of the Navy (DON). Interviews will be conducted with members of the Offices of the Secretary of the Navy and Defense, the Joint Staff, and the Office of the Chief of Naval Operations. In addition, major claimants and operational commands will be interviewed to develop ideas and concepts on how to improve the POM and budget formulation processes.

## II. PLANNING, PROGRAMMING, AND BUDGETING SYSTEM (PPBS)

### A. PPBS OVERVIEW

The Planning, Programming and Budgeting System (PPBS) is the primary process for decision-making and managing resources in the Department of Defense. PPBS was first introduced by Secretary of Defense Robert S. McNamara in 1962. Secretary McNamara brought the concept of program budgeting from the Rand Corporation where it had been developed in the 1950s. He was determined to be an active participant in preparing the DOD budget and in choosing the weapons to be developed and purchased by the military departments. Additionally, PPBS was implemented in an attempt to establish a system that would improve decision-making about the allocation of resources among a number of competing or possible programs and alternatives to accomplish specific national defense objectives. PPBS is intended to link national strategy goals to specific programs to an executable budget. (Ref. 5, pp. 1-26)

PPBS focuses on objectives and requirements, and what is necessary to meet them. PPBS, in concept, is a simple process. Based on the anticipated **threat** to national security objectives, a **strategy** is developed. **Requirements** to execute the strategy are then estimated and **programs** are developed consistent with the strategy. Finally, the costs of the approved programs are **budgeted**. (Ref. 6, p. C-2) **Figure (2)** illustrates PPBS in a linear format.



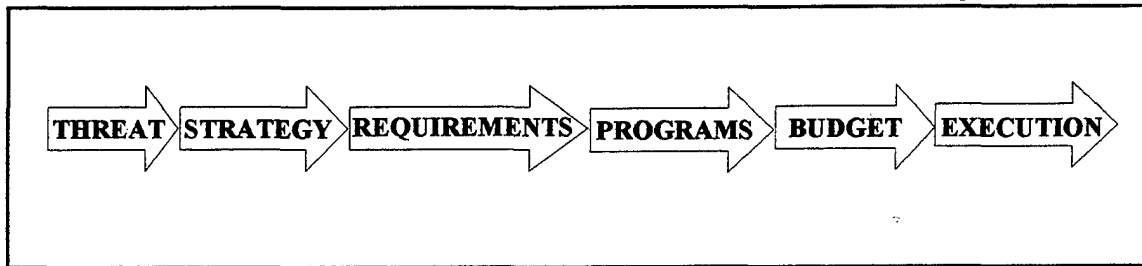
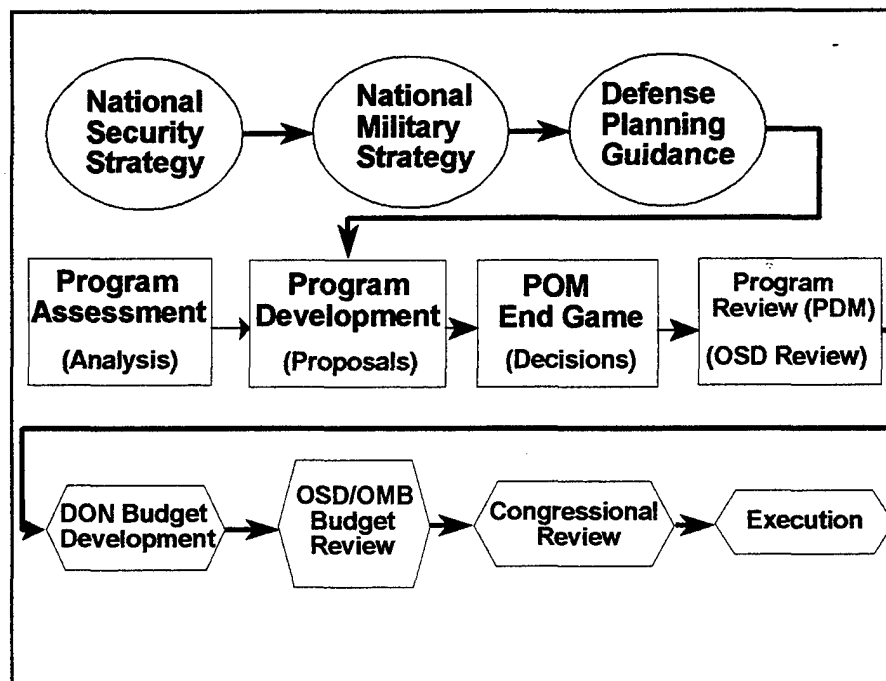

**Figure 2** Basic PPBS Process [After Ref. 6]

Although there have been many changes to the PPBS structure over the years, the basic tenets of the system have remained: three interrelated but separate phases; program and budget guidance to the military services from the Secretary of Defense (SECDEF); and, the use of quantitative analysis to choose among competing programs.

The Planning, Programming and Budgeting System (PPBS) coordinates planning efforts for national security for both the civilian and military parts of the organization. PPBS translates force requirements developed by the National Military Strategy Document (NMSD) into programs which generate budgetary requirements which are then presented to Congress as part of the President's budget.

The PPBS process operates year-round with each of three components of the procedure (planning, programming, and budgeting) working on various phases of the cycle. In reality, PPBS is not a linear process but an iterative, overlapping mechanism of assessment, review and decision all focused on one objective: to provide the operational commanders with the best mix of forces, equipment and support attainable within fiscal constraints. **Figure (3)** provides a more detailed look at the major milestones of the PPBS process.



**Figure 3** PPBS Milestones [After Ref. 7]

## B. DEPARTMENT OF THE NAVY PPBS

It is important to remember that for the Department of the Navy, PPBS is used at three interconnected levels: the military service level (CNO/CMC); the Navy Secretariat level (SECNAV); and, the Office of the Secretary of Defense level (SECDEF). The DON is unique in that consists of two military services--the United States Navy and the United States Marine Corps. Because of this distinctive organizational framework, resource allocation becomes even more complicated. In the DON two POMs--one for the Navy and one for the Marine Corps--are produced. The two sets of resources described in their respective POMs are highly interdependent, as are the departmental appropriations that follow in the budget. For example, Navy appropriations procure and support Marine Corps aircraft. (Ref. 8, p. 9) These unique

organizational and resource arrangements, among other important differences, have resulted in a PPBS within the DON that is unlike any other within DOD (Ref. 9, p. 2).

As outlined in Chapter 1, this thesis will focus on the Navy PPBS. Although, this thesis will not cover the details of Marine Corps POM development, it will discuss areas in which the two processes interconnect. The final integration of the two service POMs during the final phase, referred to as “end game,” is a key to how well the overall process is working. A volatile end game where the Secretary of the Navy referees disputes may not result in a coherent program that will survive OSD scrutiny or inter-service challenges.

A detailed examination of the Navy Planning, Programming and Budgeting phases is contained in Sections B1-B3. An approximate schedule of key events in the DON PPBS is contained in **Appendix A**. A general overview of the Navy PPBS process is illustrated in **Figure (4)**.

### **1. Planning Phase**

In the planning phase of the PPBS, the military role and posture of the United States and the DOD in the world environment are examined, considering enduring national security objectives and the need for efficient management of resources. Shaping overall defense objectives, strategies, forces and policies is the responsibility of the Office of the Secretary of Defense, the Joint Chiefs of Staff, and the Unified Commanders (CINCs). However, the Navy and the other services do play an important, yet subordinate, role in this process.

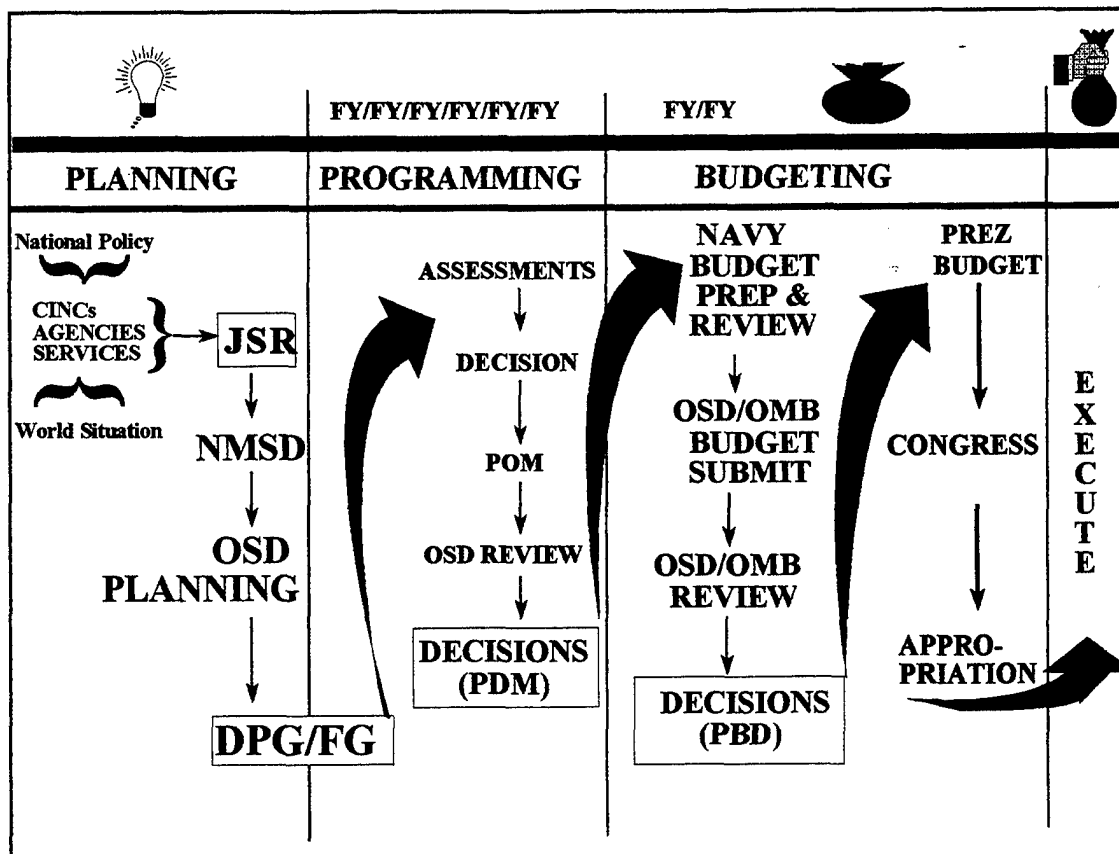

Figure 4 Navy PPBS Overview [After Ref. 7]

Much of what is the current Planning process has become is a result of passage of the 1986 Goldwater-Nichols Defense Reorganization Act (PL 99-433). This legislation made the Chairman, Joint Chiefs of Staff (CJCS) the key military advisor to the President and the Secretary of Defense (SECDEF). It also increased the role of the Unified and Specified Commander-in-Chiefs (CINCs), linking their input on warfighting requirements into PPBS. (Ref. 10) Goldwater-Nichols was designed to rectify perceived weaknesses in the Defense organizational structure and make national defense planning more efficient.

Beginning with the National Security Strategy presented to and approved by the President and culminating in the Defense Planning Guidance

promulgated by SECDEF, the Planning phase sets the framework for resource allocation that will link the national security strategy to specific programs.

**a. *Broad Overview of the Planning Strategy***

The Planning phase incorporates four major strategy steps (Ref. 6, C5-C6):

- Identify National Interests
- Examine the World Security Environment
- Define the National Military Strategy
- Plan Force Structure

(1) Identify National Interests: National interests are primarily determined by the President after receiving input from a myriad of sources, including the State Department, the National Security Council, Congress, and other executive agencies. These national interests are incorporated into the National Security Strategy of the United States.

(2) Examine World Security Environment: The basis for defense requirements in PPBS is premised on the collection and evaluation of strategic intelligence. With this information, the current and longer-term world security environment and the need for national defense is assessed. Assessing the environment includes consideration of short, medium and long-term threats to national interests, international defense policy objectives, and current defense status.

Foreign policy objectives include international treaty commitments, such as NATO, and the access needed to various parts of the

world, such as the Middle East and Panama Canal. Threats are actions that would prevent accomplishments of foreign policy objectives.

Threat evaluation in the context of our national security and that of our allies provides the basis for defining our defense needs. Once the overall threat to the security of the United States has been appraised, a national strategy for defense can be developed to counter the threat. The Central Intelligence Agency (CIA), under the Office of the President, the Defense Intelligence Agency (DIA), under the Joint Chiefs of Staff, and SECDEF are responsible for assessing the environment at the national level.

(3) Define National Military Strategy: After fully assessing the current world security environment, the next planning step is to determine the military strategy and force levels necessary to counter the threat and ensure that our defense policy objectives can be achieved. This step includes the following:

- Develop idealized strategy and required force levels (resources unconstrained).
- Apply pragmatic resource constraints.
- Develop optimal force levels and strategy under these constraints. Define goals and objectives.
- Assess the risk again and adjust force levels and strategy as necessary.

(4) Plan Force Structure: Planning decisions documented in the form of guidance provide the policy and resource direction for the programming phase. The guidance that is developed during the planning phase and documented in the programming phase will prepare Navy commands and field activities to develop programs that will lead to the achievement of goals and objectives.

**b. Planning as a Phase of PPBS**

As a result of the Goldwater-Nichols Act, the Chairman, Joint Chiefs of Staff (CJCS) has taken on a greater role in the Planning phase, namely, to ensure Commander-in-Chief (CINC) warfighting requirements are linked to the PPBS with fiscally constrained planning for all defense resources. The Goldwater-Nichols legislation established that CJCS is the principal military advisor to the President and the Secretary of Defense (SECDEF), charged with the responsibility to advise on the overall allocation of defense resources, including requirements, programs and the budget (Ref. 10). The responsibilities of the CJCS and JCS are not limited to Planning only; they are also accountable for assessment and review of programs throughout the PPBS cycle. An overview of the planning process is shown in **Figure (5)**.

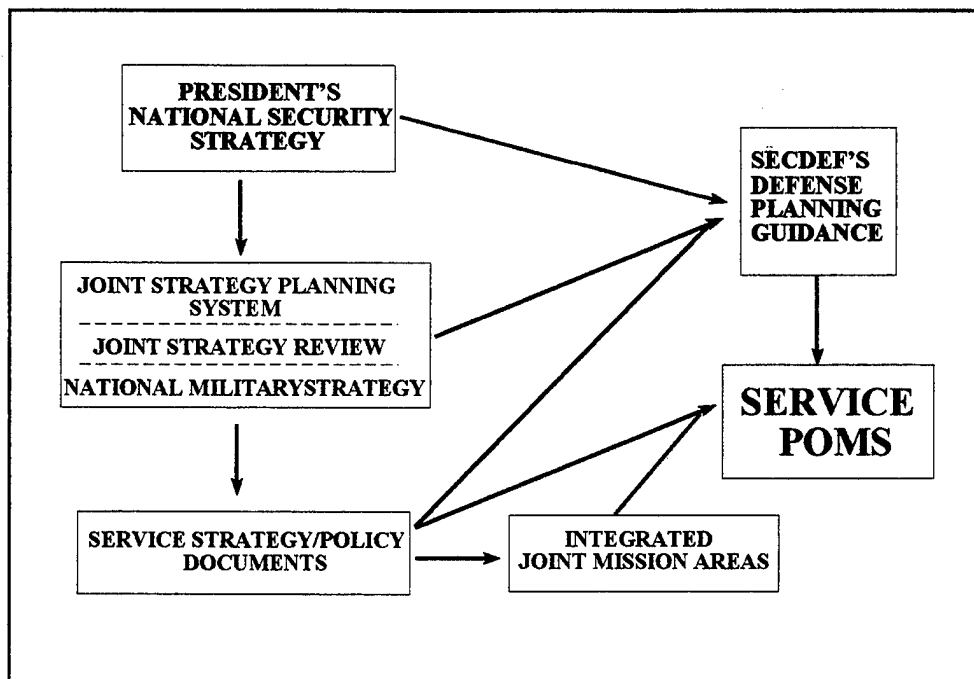

**Figure 5** Planning Process Overview [After Ref. 7]

(1) Key Personnel in the Planning Phase:

<u>Agency</u>	<u>Office</u>
OSD	USD(Policy)
JCS	J-5 (Strategic Plans and Policy)
Navy	Office of Program Appraisal
USN	N3/5 (Plans, Policy, Ops)
USMC	Plans, Policy and Operations

(2) Framework of the Planning Phase: The Planning

phase within the Joint Chiefs of Staff (JCS) takes place in the framework of the **Joint Strategic Planning System (JSPS)**. The JSPS provides the means for the JCS to review the national security environment and objectives; evaluate the threat; assess current strategy and existing doctrine, and develop guidance for



proposed programs and budgets. JSPS provides both a forum and process for Planning that occurs within the Joint Chiefs of Staff. The objective of the JSPS is to blend military advice with political and fiscal considerations in providing strategic direction and sound programs. By law, the CJCS does not give guidance to the military departments and agencies to build their programs. Rather, he gives advice to the SECDEF on what those programs should include to maximize their effectiveness. (Ref. 11, p. 11)

Activities within the JSPS include operation of the Chairman's Readiness System that conducts the Joint Monthly Readiness Review (JMRR). The JMRR feeds readiness assessments into the Joint Warfighting Capabilities Assessments (JWCA). Teams from JWCA assess joint warfighting aspects of their respective areas and recommend strategies to CJCS for inclusion in the Chairman's Program Recommendation (CPR). Additionally, JSPS is the arena in which the National Military Strategy Document (NMSD) is formulated to provide advice to SECDEF from CJCS on national military objectives, force structure and support.

The JSPS is not confined to "Planning" functions only. JWCA teams analyze Service POMs and CINC Integrated Priority Lists (IPLs), recommending areas for divestiture and recapitalization to the Joint Requirements Oversight Council (JROC) for inclusion in the Chairman's Program Assessment (CPA). The JROC is chaired by the Vice Chairman Joint Chiefs of Staff (VCJCS) and membership includes all service Vice Chiefs. The JROC ensures

the needs and deficiencies of Unified Commanders are addressed while ensuring interoperability and reducing parallel and duplicative efforts among the services. (Ref. 7, p. 55) The JCS assessment roles as well as the CINC IPLs will be examined in greater detail in the Programming section.

(3) Key Planning Documents: The major documents that are used and/or produced during the planning phase are:

- National Security Strategy of the United States.
- National Military Strategy Document.
- Chairman's Program Recommendation.
- Defense Planning Guidance.

The National Security Strategy (NSS) of the United States is authored by the President and provides a broad direction for defense planning and establishes the framework for defense planning to proceed. It is required by Section 603 of the Goldwater-Nichols Defense Department Reorganization Act (Ref. 10). The latest Presidential strategy is entitled "A National Security Strategy of Engagement and Enlargement" (February 1996). It elaborates a national security tailored for the new challenges the United States faces and builds upon America's strengths (Ref. 12, p. 1). The central goals are:

- To enhance United States security with military forces that are ready to fight and with effective representation abroad.
- To bolster America's economic revitalization.
- To promote democracy abroad.

Within these broad goals, the President identifies national interests and states his political, economic and defense strategies. The NSS describes the strategy

of engagement and enlargement in each of the world's regions. It illustrates the integration of America's commitment to the promotion of democracy and the enhancement of American prosperity with clearly defined security requirements to produce a mutually reinforcing policy.

The National Military Strategy Document (NMSD) is authored by the Chairman, Joint Chiefs of Staff (CJCS) and builds on President's National Security Strategy. The CJCS derives guidance from the National Security Strategy and, to a lesser degree, other high-level documents (e.g., Bottom Up Review by the SECDEF) to produce the NMSD. The NMSD identifies National Military Objectives and Strategic Concepts (Ref. 13, pp. 6-10). National Military Objectives include two central goals: promoting stability and thwarting aggression. Strategic Concepts include three main components: peacetime engagement, deterrence and conflict prevention, and fighting and winning wars. Additionally, two complementary strategic concepts are articulated: overseas presence and power projection. The NMSD provides force planning guidelines. It defines force requirements at the macro level. These include forces for overseas presence, forces for power projection, and forces required for winning two major regional conflicts (MRCs).

The Joint Strategy Review (JSR) is a continuous process that takes place within the JSPS domain and relates to the NMSD. The JSR assesses the strategic environment for issues and factors that may affect the National Military Strategy (NMS) in the near-term or long-range. It is an

annual report and serves as a bridge between the National Security Strategy and the National Military Strategy. The JSR begins to facilitate the integration of strategy, operational planning and programs. The JSR has wide participation by the Joint Staff, CINCs, Services, DIA, OSD, academia, and think tanks (Ref. 7, pp. 39-40).

The Chairman's Program Recommendations (CPR) provide CJCS personal recommendations to SECDEF for consideration in formulating the Defense Planning Guidance (DPG). The Recommendations represent CJCS views of programs important for enhancing joint warfighting capabilities. The CPR establishes CJCS measures of effectiveness (MOEs) for assessing Service program efficiency. JWCA teams analyze the current military situation and make recommendations for inclusion in the CPR. The Chairman's Program Recommendations is a major input into the Defense Planning Guidance.

The Defense Planning Guidance provides SECDEF planning guidance and fiscal constraints to the military departments and services for POM development. It provides a link between the Planning and Programming phases of PPBS. The principal drafter is the Under Secretary of Defense (Policy) with reviews and comments by the Services, CINCs and Joint Staff. The DPG freezes "Planning" phases for construction of the POM. The DPG is mainly derived from three inputs: the President's National Security Strategy, the Chairman of the Joint Chiefs of Staff's National Military Strategy Document (NMSD), and the Chairman's Program Recommendations (CPR).

The DPG plays a direct role in the PPBS as guidance for POM preparation. It specifically provides force and fiscal guidance to the services in order for the services to prepare their POMs. The DPG:

- Defines the threat against which DOD programs are measured.
- States national and defense policy objectives and strategy.
- Provides resource and forces planning guidance.
- Establishes the fiscal guidelines for the oncoming programming phase (Ref. 14, pp. 12-18).

The DPG provides to the components of DOD the policy, force and fiscal guidance necessary to construct their respective program proposals and, ultimately, their annual budgets. The DPG provides fiscal guidance at the Total Obligational Authority (TOA) level for each of the services and defense agencies for the next six years. The fiscal guidance provides the overall constraint within which the services must construct programs. As such, the DPG is the yardstick by which the military departments and services make programming and budgeting decisions. Services develop their program proposals in accordance with the DPG while OSD and the Joint Staff use it as the baseline for program review. Once developed, the draft Defense Planning Guidance (DPG) is presented to the Secretary of Defense and to the CINCs of the unified commands. The CINCs have an opportunity to comment on the draft DPG and meet with SECDEF and the Defense Planning and Resource Board (DPRB) to discuss their views and recommendations. The DPRB assists the Secretary of Defense in major program decision making not only in the Planning

phase but also in the resolution of Program Review issues. **Figure (6)** delineates the membership of the DPRB.

<b>Defense Planning and Resources Board (DPRB)</b>
Deputy Secretary of Defense (Chairman)
Executive Secretary: Director Program Analysis & Evaluation
Chairman Joint Chiefs of Staff (Vice Chairman)
Under Secretary of Defense (Comptroller)
Under Secretary of Defense (Policy)
Under Secretary of Defense (Acquisition)
Under Secretary of Defense (Personnel and Readiness)
Vice Chairman Joint Chiefs of Staff
Secretary of the Navy
Secretary of the Army
Secretary of the Air Force

**Figure (6) DPRB Members**

During development of the DPG, service inputs are also solicited, and draft copies are circulated for comment. As the Services raise issues during the review of the draft DPG, they are deliberated by the Defense Planning and Resources Board (DPRB). After the DPRB discusses the issues presented to it, it forwards recommendations to the SECDEF.

After considering the views of the DPRB, the SECDEF makes final decisions and signs the DPG. Once the DPG is signed, the planning cycle is formally completed and the programming phase commences. The signed Defense Planning Guidance is the final product of the "Planning" phase of PPBS and the basis for the programming phase.

In summary, the Defense Planning Guidance contains the collective work of the SECDEF, CJCS, JCS, the Services, and the President. The DPG is the basis for the services to prepare their POM. While defense planning is continuous and iterative, the DPG “freezes” planning to enable construction of POMs, i.e., the DPG takes a single frame of reference point to enable programming to be accomplished (Ref. 7, p. 57).

## **2. Programming Phase**

Programming is the process by which information in the Defense Planning Guidance (DPG) is translated into a financial plan of effective and achievable programs (Ref. 6, C-7). Programming produces a midrange plan for the DON. The programming phase results in the development of the POM, a detailed six fiscal year program-specific outline of how the Department of the Navy intends to spend its money and allocate manpower.

### **a. Key Navy Staff**

Navy Staff is organized to conduct programming and budgeting process management within the N8 organization. **The Deputy Chief of Naval Operations (Resources, Warfare Requirements and Assessment) (N8)** is the executive agent for the Navy PPBS. Under N8 are:

- Director, Programming Division (N80)
- Director, Assessment Division (N81)
- Director, Fiscal Management Division (N82)

N82 is “dual-hatted” in the Navy Secretariat as the Director, Office of Budget (FMB).

Other key players include: the Resources and Requirements Review Board (R<sup>3</sup>B), the Integrated Resources and Requirements Review Board (IR<sup>3</sup>B), R<sup>3</sup>B Executive Panel, Resource Sponsors, Appropriation Sponsors, Navy Staff Executive Steering Committee (ESC), and DON Program Strategy Board (DPSB).

(1) Resources and Requirements Review Board (R<sup>3</sup>B): This board is the principal review forum in the revamped Navy program process. It is the Navy executive board for, “. . . assessing joint warfare mission and support areas of the Navy, deciding warfare requirements and resource issues, and coordinating the planning, programming and budgeting process” (Ref. 15, p. 1). The R<sup>3</sup>B oversees the Joint Mission Area/Support Area (JMA/SA) assessment process that develops a consensus among the Navy’s senior leadership about the size, structure and operating character of the future Navy (Ref. 16, pp. 5-6). Originally, the seven Joint Mission Area (JMA) and four Support Area (SA) assessment teams briefed the R<sup>3</sup>B, to review programs for modification or cancellation. The R<sup>3</sup>B then set direction and provided guidance regarding the recommendations arising out of the assessment process.

In July 1994, N8 issued a guidance memorandum for Program Review 1997 (PR 97) to revise the R<sup>3</sup>B to include more Marine Corps personnel (Ref. 17, p. 9). This was needed to ensure a more integrated approach to assessing Navy programs. The R<sup>3</sup>B with the increased Marine representation is now called the **Integrated Resources and Requirements**



**Review Board (IR<sup>3</sup>B).** This structure is designed so that the two Services participate in an integrated program planning process where inter-Service disagreements surface earlier than if the two Services prepared their POMs completely independently. Deputy Chief of Naval Operations (Resources, Warfare Requirements and Assessments) (N8) and Marine Corps Deputy Chief of Staff for Programs and Resources (P&R) serve as co-chairs on the IR<sup>3</sup>B. Now, JWA/SA assessment briefs are presented to the IR<sup>3</sup>B. Briefs to the IR<sup>3</sup>B by N81 form the basis of the Investment Balance Review.

The original R<sup>3</sup>B still presides over the “Navy only” portion of the POM process including review of the Sponsor Program Proposals and examination of the Navy Tentative POM (TPOM). **Figure (7)** lists the members of the R<sup>3</sup>B.

The **R<sup>3</sup>B Executive Panel** provides a forum in which the chairman of the R<sup>3</sup>B consults with other OPNAV leaders of comparable seniority on an issue prior to making a decision or referring an issue for decision to a higher level. It is not intended to serve as an additional forum to debate issues already decided at the R<sup>3</sup>B or other decision forum (Ref. 18, p. 2). **Figure (8)** lists the principals of the R<sup>3</sup>B Executive Panel.

Resources & Requirements Review Board	Code	Rank
DCNO(Resources, Warfare Requirements & Assessments)(Chairman)	N8	☆☆☆
Director, Programming Division	N80	☆☆
Director, Assessment Division	N81	☆☆
Director, Fiscal Management Division	N82	☆☆
Director, CINC Liaison Division	N83	☆☆
ACNO (Expeditionary Warfare Division)	N85	☆☆
ACNO (Surface Warfare)	N86	☆☆
ACNO (Submarine Warfare)	N87	☆☆
ACNO (Air Warfare)	N88	☆☆
Director, Special Programs Division	N89	☆☆
Director, Total Force Programming/Manpower	N12	☆☆
Asst DCNO (Logistics)	N4B	☆☆
Director, Strategy and Policy Division	N51	☆☆
Deputy Director, Naval Intelligence	N2B	☆-equiv.
Deputy Director, Space & Electronic Warfare	N6B	☆☆
Deputy Director, Naval Training	N7B	☆☆
Director on Navy Test & Eval & Tech Rqmts	N091	☆☆
Director of Naval Reserve	N095	☆☆
Oceanographer of the Navy	N096	☆☆
Commandant of the Marine Corps (Aviation)	Marines	☆☆
Commandant of the Marine Corps (Rqmts & Programs)	Marines	☆☆
Vice Commander, Naval Air Systems Command	Air 09/8 0	☆☆
Vice Commander, Naval Sea Systems Command	Sea 09	☆☆
Vice Commander, Space & Naval Warfare Systems Command	05	☆☆
Chief of Information	N09C	☆☆
Chief of Legislative Affairs	OLA	☆☆
Director, Office of Program Appraisal	OPA	☆☆☆

Figure 7 Resources and Requirements Review Board (R<sup>3</sup>B)

<b>R<sup>3</sup>B Executive Panel</b>	<b>Code</b>	<b>Rank</b>
<b>DCNO(Resources, Warfare Requirements &amp; Assessments)(Chairman)</b>	<b>N8</b>	<b>☆☆☆</b>
<b>Director, Programming Division</b>	<b>N80</b>	<b>☆☆</b>
<b>Director, Assessment Division</b>	<b>N81</b>	<b>☆☆</b>
<b>Director, Fiscal Management Division</b>	<b>N82</b>	<b>☆☆</b>
<b>Director, CINC Liaison Division</b>	<b>N83</b>	<b>☆☆</b>
<b>DCNO (Plans, Policy and Operations)</b>	<b>N3/N5</b>	<b>☆☆☆</b>
<b>DCNO (Logistics)</b>	<b>N4</b>	<b>☆☆☆</b>
<b>Commander, Naval Air Systems Command</b>	<b>NAIR-00</b>	<b>☆☆☆</b>
<b>Commander, Naval Sea Systems Command</b>	<b>SEA-00</b>	<b>☆☆☆</b>
<b>Commander, Military Sealift Command</b>	<b>N00</b>	<b>☆☆☆</b>
<b>Director of Space and Electronic Warfare</b>	<b>N6</b>	<b>☆☆☆</b>
<b>Naval Inspector General</b>	<b>N09G</b>	<b>☆☆☆</b>
<b>Director of Naval Training</b>	<b>N7</b>	<b>☆☆☆</b>

**Figure 8 R<sup>3</sup>B Executive Panel**

(2) Resource Sponsor: Resource Sponsors are the Navy staff, Deputy CNOs or Division Directors responsible for, “. . . an identifiable aggregation of resources which constitute inputs to warfare and supporting tasks, such as air, surface or subsurface warfare” (Ref. 19, p. I-23). The Resource Sponsors are responsible for groups of programs and program elements that comprise a warfare or support area. The Resource Sponsors are responsible for developing the programs under their cognizance during the programming phase. Specifically, they are provided guidance and Total Obligational Authority (TOA) levels to generate their portion of the POM input.

During the budgeting phase, they are responsible for providing the programmatic guidance to reconcile changes that occur due to repricing, rescheduling or other factors. **Figure (9)** lists the Navy Resource Sponsors:

<b>Resource Sponsor</b>	<b>Sponsor Area</b>
DCNO (Manpower & Personnel) (N1)	Manpower & Personnel
DCNO (Manpower & Personnel) (N1)	Family Housing/BOS/MILCON
Director of Naval Intelligence (N2)	Intelligence
DCNO (Logistics) (N4)	Logistics/Strategic Sealift
Director Space & Electronic Warfare (N6)	Space & Electronic Warfare
Director of Naval Training (N7)	Training
Director Assessment Division	Assessment Studies
Director Expeditionary Warfare (N85)	Expeditionary Warfare
Director Surface Warfare Division (N86)	Surface Warfare
Director Submarine Warfare Division (N87)	Submarine Warfare
Director Air Warfare (N88)	Air Warfare
Director Navy Test & Eval & Tech Rqmts (N091)	Science & Tech/Test & Eval
Surgeon General of the Navy (N093)	Medical
Oceanographer of the Navy (N096)	Oceanography
Assistant VCNO (N09B)	Administration

**Figure 9** Navy Resource Sponsors

(3) Appropriation Sponsor: An Appropriation Sponsor is a Deputy Chief of Naval Operations (DCNO), Assistant Chief of Naval Operations (ACNO) or Deputy Chiefs of Staff (DCS) responsible for supervisory control over a designated appropriation. Once a program is defined that provides for force level requirements and program objectives, the appropriation sponsor becomes the DON spokesman on matters dealing with resource requirement. This

involves assisting program and resource sponsors in dealing with funding deficiencies during budget formulation, testifying before Congress, and recommending reprogramming of funds within appropriations during budget execution. (Ref 19, p. I-23) Appropriation Sponsors are listed in **Figure (10)**.

<b>Appropriation Sponsors</b>	<b>Code</b>	<b>Appropriation</b>
Director, Fiscal Management Division	N82	Other Procurement, Navy (OPN)
Director, Fiscal Management Division	N82	Operations & Maintenance, Navy (O&M,N)
ACNO (Surface Warfare)	N86	Ships Conversion, Navy (SCN)
ACNO (Surface Warfare)	N86	Weapons Procurement, Navy (WPN)
ACNO (Air Warfare)	N88	Aircraft Procurement, Navy (APN)
DCNO (Manpower & Personnel)	N1	Military Personnel, Navy (MPN)
DCNO (Logistics)	N4	Military Construction (MILCON)
DCNO (Logistics)	N4	National Defense Sealift Fund (NDSF)
DCNO (Logistics)	N4	Family Housing, Navy (FH,N)
Director Navy Test/Eval & Tech Rqmts	N091	Research, Development, Test/Eval (RDT&E)
Director of Naval Reserve	N095	Military Construction, Naval Reserve (MCNR)
Director of Naval Reserve	N095	Reserve Personnel, Navy (RPN)
Director of Naval Reserve	N095	Operations & Maintenance, Navy Res (O&M,NR)

**Figure 10** Navy Appropriation Sponsors

(4) Navy Staff Executive Steering Committee (ESC): The purpose of this committee is to provide policy recommendations to the CNO on issues that have limited resource or warfighting implications. Although not a component of the CNO executive decision making process, the Navy Staff Executive Steering Committee may recommend that issues be sent to either the

CNO Executive Board (CEB) or the Resources and Requirements Review Board (R<sup>3</sup>B). The composition of this informational forum is established by the Vice Chief of Naval Operations (VCNO) (Ref. 18, p. 1).

(5) DON Program Strategy Board (DPSB): This high-level board meets periodically to review and assess important events during the Navy PPBS such as Summary Brief of JWA/SA assessments and the Investment Balance Review (IBR). The DPSB oversees the final integration of Navy and Marine Corps POMs into a total DON package for submission to OSD. DPSB members are listed in **Figure (11)**:

<b>DON Program Strategy Board (DPSB)</b>
<b>Secretary of the Navy (Chairman)</b>
<b>Chief of Naval Operations</b>
<b>Commandant of the Marine Corps</b>
<b>Under Secretary of the Navy</b>
<b>Vice Chief of Naval Operations</b>
<b>Asst. Commandant of the Marine Corps</b>
<b>Asst. Secretary of the Navy (RD&amp;A)</b>
<b>Asst. Secretary of the Navy (I&amp;E)</b>
<b>Asst. Secretary of the Navy (M&amp;RA)</b>
<b>Asst. Secretary of the Navy (FM&amp;C)</b>
<b>Director, Office of Program Appraisal</b>

**Figure 11** DPSB members

**b. Key Navy Programming Documents**

(1) Program Objectives Memorandum (POM): The POM is the Secretary of the Navy's biennial recommendation to the SECDEF for the detailed programmatic application of Department of Navy resources. The POM contains information on all Navy programs planned for a six year period. The first two years of the POM will later be translated into the Secretary of the Navy's budget that becomes part of the President's budget submitted to Congress after OSD and SECDEF review and approval. The last four years are used as the starting point for the next POM after updating to reflect new initiatives and adherence to new planning guidance. POMs are constructed during even numbered years to reflect the biennial DOD budget. In odd years a Program Review is conducted to update any changes to the POM.

(2) Future Years Defense Program (FYDP): The FYDP is the basic DOD programming document. It is a publication of decisions approved by SECDEF on the DOD program for a six year period. The FYDP is an integrated program document that displays forces, costs, manpower, procurement and construction in the approved programs (Ref. 6, p. C-14). Data is constructed in two ways: Major Force Programs (for DOD review) and Appropriation (for Congressional review). This two-dimensional structure provides a comprehensive approach to accounting for, estimating, identifying, and allocating resources to individual or logical groups of organizational entities,

major combat force or support programs referred to as program elements (PEs)(Ref. 20, p. 5-1). The FYDP is updated several times during the biennial cycle:

On-Year:	FEB (Pres. Budget), May (POM), Oct (BES)
Off-Year:	FEB (Pres. Budget) Oct (BES)

(3) Resource Allocation Display (RAD): The RAD is a computerized spreadsheet display showing the allocation of Navy resources. The RAD is updated many times during the programming phase and reflects the most current FYDP data. RADs are numbered I to XII signifying different stages of the programming and budgeting cycle. The final RAD is the Navy POM as it is submitted to the Office of the Secretary of Defense. Odd numbered RADs are sorted by and issued to Resource Sponsors; even numbered RADs are issued to Claimants.

***c. Programming Sub-phases***

There are three distinct yet interrelated subphases within the programming phase. They are:

- Program Assessment
- POM Development
- POM Delivery & OSD Program Review

The programming subphases translate planning for forces and fiscal guidance into achievable programs. Programmers start with the program years (the last four years of the previous POM cycle) and revise and update past estimates rather than developing programs from scratch.



(1) Program Assessment: Program Assessment primarily serves to appraise warfare and support programs and to assess the state of the Navy. The Navy assessment process is led by the Director, Assessment Division (N81). The purpose of this process is to provide a continuous review of Navy program joint warfighting and forward presence capabilities and its resource requirements. The assessment process provides an integrated review of DON requirements and resources. The results of this assessment are reflected in subsequent decisions on programming priorities. (Ref. 21, p. 1)

The programming assessment process begins with the issuance of **POM Serial One**. The POM serials are a series of memorandums from N80 to all offices participating in the development of the POM. POM Serial One provides initial guidance for preparing the Navy Program Objectives Memorandum (POM). Procedures and documentation requirements for each major event in the POM cycle are provided in subsequent POM serials (Ref. 22, p. 1). The actual assessment work really begins a few months before issuance of POM Serial One, however, POM Serial One formally provides initial documentation and schedules for the upcoming POM. **Figure (12)** illustrates the Program Assessment (or Planning) subphase.

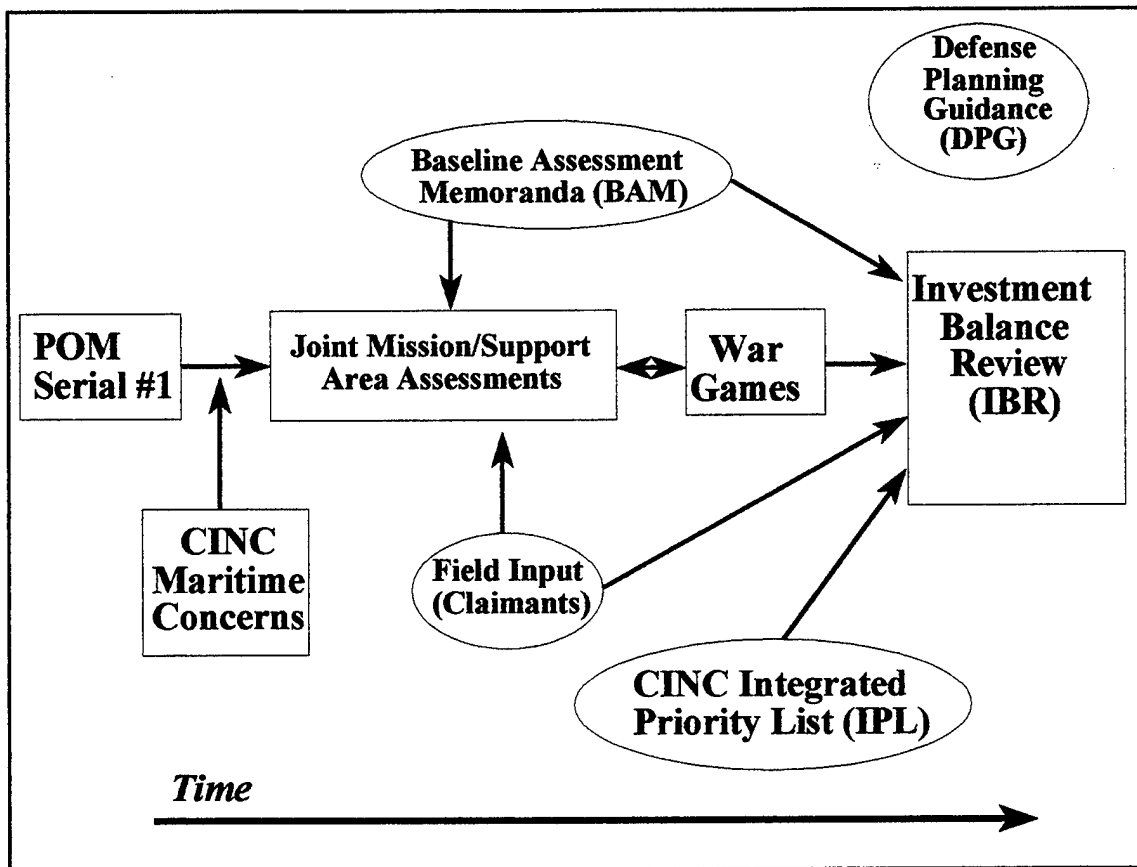

Figure 12 Program Planning Sub-phase Overview

[After Ref. 7]

**CINC Maritime Concerns** provide the Unified Commanders an opportunity to address top maritime issues at the beginning of the programming assessment phase for future consideration during the Joint Mission Area/Support Area (JMA/SA) assessments. The Unified Commanders are as follows:

- European Command
- Pacific Command
- Southern Command
- Special Operations Command
- Atlantic Command
- Central Command
- Space Command
- Transportation Command

The **Baseline Assessment Memorandum (BAM)** provides independent analysis of the funding required to reach specified levels of capability for a particular program (e.g., ship depot maintenance, spares funding). These assessments address programs that cut across several resource sponsors. The purpose of the BAM is three-fold: (1) to aid Resource Sponsors in determining appropriate funding levels during Sponsor Program Proposal (SPP) development; (2) to assist in developing POM Preliminary Programming Guidance; and (3) to provide a vehicle for conducting a post-SPP Assessment of how allocated resources meet requirements and POM Preliminary Programming Guidance. (Ref. 22, p. 2)

BAMs provide Resource Sponsors with baseline costs for projected force levels and specific programmatic support requirements. As the reference against which Resource Sponsors measure their proposed programs, BAMs provide the programming process with the most current budget decision and execution data. They are a rigorous and independent assessment of critical or necessary funding requirements. **Figure (13)** lists the Baseline Assessment Sponsors.

<b>Assessment Area</b>	<b>Sponsor</b>
Ship Depot Maintenance	N4
Ship Intermediate Maintenance	N4
Ship Inactivation	N4
Spares	N4
Shore Environmental Quality Program	N4
Afloat Environmental Quality Program	N4
DON Environmental Restoration	N4
Base Operating Support	N4
Military Construction	N4
Family Housing	N4
Non-Nuclear Ordnance Procurement/ Maintenance	N4
DON BRAC Execution	N4
Training Technology	N7
Manpower and Personnel	N1
Base Information Infrastructure	N6

**Figure 13** Baseline Assessment Area Sponsors

**CINC Integrated Priority Lists (IPLs)** provide CINCs with a process to submit prioritized issues to the programming phase. Input is by means of the Integrated Priority Lists (IPLs) submitted per OSD direction. After receipt of the Unified CINCs' IPLs, Component Commanders submit Component Issue Papers (CIPs) as a reference, providing programmatic background and focus for IPL issues (Ref. 22, p. 4). Component Commanders may also input no more than five of their own non-IPL concerns. OPNAV responds to these

Component Commander issue papers in Sponsor Program Proposal (SPP) and Sponsor Program Proposal Documents (SPPDs) (Refs. 23, p. 1; 24, p. 1).

CINCs are not limited in the number of issues that can be submitted, nor are they required to identify offsets, as are the claimants.

Concerns addressed by the CINCs must be answered in the POM, and resource sponsors must identify action taken on each issue.

### **Joint Mission Area/Support Area (JMA/SA) Assessments**

provide the basis for discussion of program validity and tradeoffs for senior Navy leadership. These are designed to cut across the concerns of traditional platform and naval warfare areas and employ new capabilities for evaluating cost and benefits of proposed alternatives. Assessments support development of a DON investment strategy based on established and developing concepts for the employment of Naval Forces, mission/capability priorities, as well as DON standards for support, training, readiness and manpower (Ref. 21, pp. 1-2).

The goals of the JMA/SA process are to:

- Build a consensus as to the future size, structure, and character of the Navy.
- Incorporate a new joint perspective to Navy force planning.
- Achieve closer Navy-Marine Corps integration.
- Shift planning priorities toward littoral warfare.
- Minimize the disruptive forces that would result from decreases in the defense budget. (Ref. 25, p. 20)

The JMA/SA teams complete their portion of the assessment process with briefs to the IR<sup>3</sup>B. At this point, N81 creates the first proposal for the Investment Balance Review (IBR). The JMA/SA establish the explicit link between required joint operational capabilities and Navy-Marine Corps programs and budget (Ref. 1, p. 47). The DON JMA/SA groups are a parallel version of the JCS Joint Warfighting Capabilities Assessment (JWCA) teams. **Figure (14)** shows the DON JMA/SA areas.

**Wargaming** has achieved a new emphasis as a decision process tool. Wargames are a medium in which program planners can explore the interactions of systems and operational concepts in specific scenarios. Wargaming has become an integral part of the evaluation of Joint Mission Area/Support Area assessments emphasizing program balance and potential tradeoffs. It is utilized by programmers to assess capabilities versus DPG scenarios and strategic concepts.

**Investment Balance Review (IBR)** is led by N81. It is the culmination of the JMA/SA assessment review process and compiles all the JMA/SA recommendations into a single program for discussion, review and approval by the IR<sup>3</sup>B. The IBR is also briefed by N81 to the CINCs, CEB and DPSB. The IBR provides a broad framework from which to commence the more detailed level of programming required to produce a justifiable POM. The IBR serves as the critical bridge between program planning and POM development.

<b>Joint Mission Area</b>	<b>Lead</b>
Joint Strike	N88
Joint Littoral Warfare	N85
Intelligence, Surveillance, & Reconnaissance (ISR)	N87
Nuclear Deterrence/Counterproliferation of Weapons Of Mass Destruction	N87
Maritime Support of Land Forces (MLSF)	N86/N42
Forward Engagement/Conventional Deterrence (FED)	N51
Command, Control, Communications, Computers and Information Warfare	N6B
<b>Support Areas</b>	
Manpower and Personnel	N12
Readiness	N81
Support and Infrastructure (S&I)	N4B
Training	N7B
<b>Other Teams</b>	
Special Programs	N89
Force Structure & Presence	N81
Non-Acquisition RDT&E	N091

**Figure 14** DON JWA/SA Teams

The IBR results serve as direct input into the Department of the Navy Programming Guidance (DONPG) and N80 Preliminary Programming Guidance (PPG) (Ref.16, pp. 39-41). Completion of the IBR is the end of the “program planning” phase and the commencement of the program development phase.

Program Assessment/Planning Summary: Assessments are intended to provide the basis for development of a DON strategy based on established and developing concepts for the employment of Naval Forces, mission/capability priorities, as well as service or common DON standards for support, training, readiness and manpower. Assessments and the subsequent Investment Balance Review (IBR) analyze and balance those DON warfighting, crisis response, and support capabilities required to fulfill the naval services' roles in execution of the national military strategy. They provide options to the DON leadership for program alternatives that compare opportunities and costs for accomplishing various capabilities. The process should develop a DON investment strategy that properly supports the highest-priority naval capabilities.

(2) POM Development: The POM Development phase begins with the issuance of the Defense Planning Guidance (DPG) by the SECDEF. Specifically for the Navy, the development phase begins upon completion of the Investment Balance Review (IBR). The development of the Navy POM is guided by the Director, Programming Division (N80). **Figure (15)** illustrates the POM development sub-phase of Programming.

The first step in the POM development process is delivery by N80 of the **Preliminary Program Guidance (PPG)**, one of many POM serials (Ref. 26, pp. 1-2). The PPG documents initial investment guidance for Navy programs based on results of DON JMA/SA Assessments and the IBR. It will provide specific programming and fiscal guidance to Resource Sponsors for



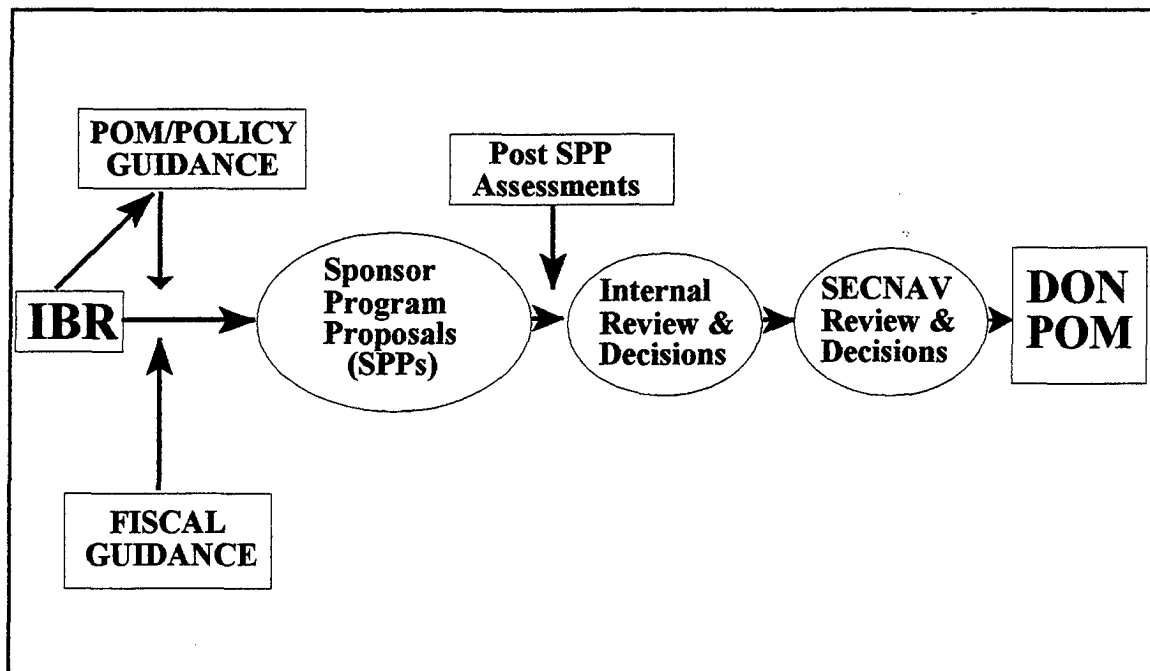

Figure 15 POM Development Sub-phase [After Ref. 7]

development of Sponsor Program Proposals (SPPs) (Ref. 26, p. 1) . N80 will consider Unified CINC, Component Commander and Claimant input in writing this guidance. Hence, the PPG is the blueprint for POM development (Ref. 22, p. 2).

N80 provides revised programming and fiscal guidance as appropriate after issuance of **DOD Fiscal Guidance** and the Defense Planning Guidance (DPG) . The Fiscal Guidance provided by the Secretary of the Defense will distribute shares to the military departments and establish Total Obligational Authority (TOA) controls for each year of the FYDP.

Upon receipt of the PPG, Resource Sponsors will adjust their programs to meet prescribed fiscal and programmatic direction. This is also the Sponsor's opportunity to make technical corrections, fact-of-life cost

adjustments and other zero-sum changes within the bounds of their fiscal guidance to reflect program changes (Ref. 22, p. 2).

Changes made by the Resource Sponsors as a result of fiscal and programmatic guidance will comprise the **Sponsor Program Proposals (SPPs)**. SPPs represent the major initial proposals for the Navy POM. Resource Sponsors use the latest fiscal and planning guidance on program changes to adjust and update their programs. The SPPs are the sponsors allocation of their resources to support Navy objectives as adjusted by the PPG. They must also address the results of the IBR, the CINC IPLs, and Component Commander and Claimant Issue Papers. In odd year Program Reviews, Resource Sponsors will submit Sponsor Change Proposals (SCPs) to document any changes or adjustments to the original POM submission.

**Claimant Issue Papers** provide major claimants, such as Commander-in-Chief Atlantic Fleet (CINCLANTFLT), Naval Air Systems Command (NAVAIR) or Naval Supply Systems Command (NAVSUP), the opportunity to participate in the Resource Sponsor SPP development. Each claimant may identify 25 prioritized issues (maximum of five per Resource Sponsor) and must accompany each with program/financial offsets. Claimant issues are routed to the Resource Sponsors for consideration and disposition. The Resource Sponsor will respond to the five issues within their sponsorship in the Sponsor Program Proposal Document (SPPD) (Ref. 24, pp. 1-3).

SPPs are then briefed to the R<sup>3</sup>B and addresses the program necessary to meet POM program and fiscal guidance and show/explain the effect of those changes on Resource Sponsor program baselines.

**Sponsor Program Proposal Documents (SPPDs)** are developed by the Resource Sponsors documenting their presentations and are submitted to N83 in response to Component Commander Issue Papers or to N80 in response to Claimant Issue Papers. They must address the Component Commander's issues in programmatic detail (Ref. 23, p. 2). They must also address each Claimant's top five issues in programmatic detail (Ref. 24, p. 3).

Following the SPPs, designated resource sponsors prepare **Post-SPP Assessments**. These are written reports that provide an evaluation of programs as proposed in SPPs. Post-SPP Assessments analyze the degree to which SPPs meet Preliminary Program Guidance and BAM recommendations. The Baseline Assessment Sponsor highlights any significant funding deficiencies and provides appropriate recommendations to N80.

Completion of SPPs, SPPDs and Post-SPP Assessments is followed by presentations to the R<sup>3</sup>B by the Resource Sponsors. After reviewing the SPPs for compliance with guidance, the R<sup>3</sup>B makes its adjustments to the SPPs. Changes to the SPPs are called "ZOWs" (an acronym for "Zumwalt's Own Words", originating when the former CNO would make unilateral decrees on programming issues sometimes to the chagrin of his staff officers). N80 then compiles the SPPs into a complete POM proposal. The complete program is

briefed to the Navy Staff Executive Steering Committee, and then to the CNO Executive Steering Committee (ESC) for decisions on policy issues. Following this, the CNO then approves the Navy Tentative POM (T-POM). This OPNAV internal review is also referred to as the Navy "end game," as it occurs at the end of the programming process within the Navy only phase.

The Navy program is then combined with the Marine Corps program and briefed to the DPSB (refer to figure 11) by N80 and Deputy Chief of Staff (Programs and Resources), USMC. During the DPSB meeting, concerns of Navy Secretariat are addressed. Upon completion of the review by the DPSB, and approval by SECNAV, the official DON POM is submitted to the Office of the Secretary of Defense (**Appendix B** provides a schedule for POM-98). Although submission of the DON POM to OSD is the end to the DON programming phase many of the same players will be involved in the OSD program review that follows.

(3) **POM Delivery and OSD Program Review:** The submission of the POM to the Office of the Secretary of Defense (OSD) signals the beginning of the issue development and defense program review by OSD under the purview of the **Defense Planning and Resource Board (DPRB)** (Figure 6) and the **Program Review Group (PRG)**. **Figure (16)** outlines the POM delivery and OSD review sub-phase.

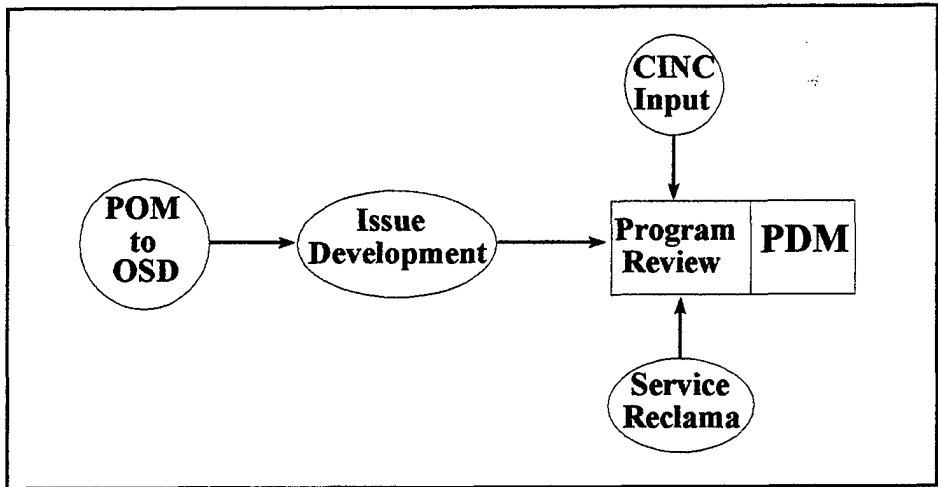

**Figure 16** POM Delivery and OSD Program Review Sub-phase [After Ref. 7]

The DPRB assists the SECDEF in major program decision making. The DPRB is involved throughout the PPBS process, most importantly in preparation of the Defense Planning Guidance (DPG) and in the resolution of Program Review issues.

The Program Review Group (PRG) serves as a subordinate group to the DPRB. Its purpose is to screen and develop issues before they are deliberated by the DPRB (Ref. 27, Attachment A, p.2). **Figure (17)** shows the PRG membership.

Program issues are major program items designated by the Deputy Secretary of Defense (DEPSECDEF) requiring high-level attention. Aside from those issues raised by DEPSECDEF, issues raised by any DPRB member, any defense senior executive responsible for a portion of the defense program, or CINC can be addressed in an **Issue Paper**. These issues are

<b>Program Review Group</b>
- Director, Program Analysis and Evaluation (PA&E) (Chairman)
- Principal Deputy Under Secretary of Defense (Comptroller)
- Principal Deputy Under Secretary of Defense(Acquisition and Technology)
- Assistant Secretary of Defense (Force Management Policy)
- Assistant Secretary of Defense (Strategy and Requirements)
- Assistant Secretary of Defense (C3I)
- Assistant Secretary of Defense (Health Affairs)
- Assistant Secretary of Defense (Reserve Affairs)
- Army Deputy Chief of Staff (Operations and Plans)
- Navy Deputy Chief of Naval Operations (N8)
- Marine Corps Deputy Chief of Staff (Programs and Resources)
- Air Force Deputy Chief of Staff (Plans and Operations)
- Joint Staff Director for Force Structure, Resources and Assessment (J-8)

**Figure 17** Program Review Group (PRG) Membership

reviewed by Assistant Secretary of Defense (Program Analysis and Evaluation) (DPA&E) for possible consideration by the PRG.

Issue Development Teams are designated to lead the development and evaluation of those issues that DEPSECDEF has selected for review as Major Issues. Teams contain members from OSD, Joint Staff and the military department with the team leader being from OSD or the Joint Staff. The Issue Teams formulate a set of alternatives for decision. Alternative I is always the POM position (Ref. 27, p. 2). Issue Teams brief the PRG initially on how they framed their issue for study. The PRG provides guidance if further work on the issue is required, or if the issue is ready to be presented to the DPRB for decision.

Issues presented in the form of Issue Papers to DPA&E are assembled into an Issue Decision Book which are circulated to PRG members. The Issue Books reflect the OSD position, CINC input and service position (reclama). DEPSECDEF decides issues presented in the Decision Book.

SECDEF decides the Major Issues and, along with DEPSECDEF's decisions on the issues in the Decision Book, announce them in the form of a Program Decision Memorandum (PDM) to the military departments and defense agencies, with instructions to submit their budgets in accordance with those decisions. **Figure (18)** illustrates a flow chart of the OSD Program Review. The PDM officially modifies the service POM inputs and provides OSD approved baseline to commence budget formulation. The PDM is the closing document of the DOD programming phase.

### **3. Budgeting Phase**

A budget may be defined as a document that expresses in financial terms the plan for accomplishing organization objectives for a specified period of time. It is an instrument for planning, decision-making, and management control, as well as a statement of priorities. The budgeting phase of PPBS is where programmatic demands must be matched by dollars. The somewhat "relaxed" financial constraints applied in the Planning and Programming phases tighten under Budget Authority (BA) and Total Obligational Authority (TOA) controls. Inherent in the Department of Navy budget process is the basic policy that the

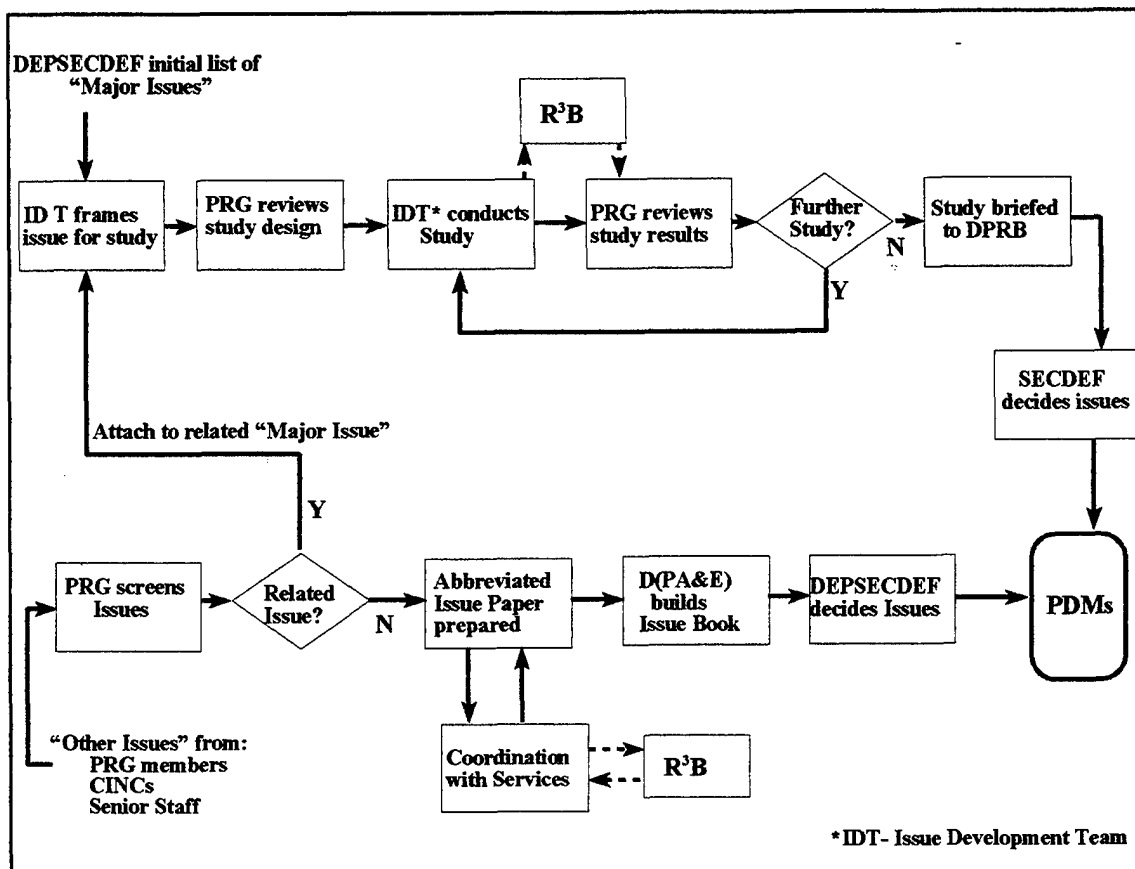

Figure 18 OSD Program Review [After Ref. 27]

offices responsible for executing budgets should participate in developing budget estimates, subject to the guidance and decisions of higher authority e.g., the CNO and SECNAV. The first two years of the approved POM forms the baseline for creation of service budgets. These two years reflect the Congressional requirement in the FY 86 Defense Authorization Act to submit a biennial budget commencing with FY 1988/1989. The budgeting function in the DON rests with the Office of Budget (FMB) in the Navy Secretariat, under the Assistant Secretary of the Navy for Financial Management and Comptroller [ASN(FM&C)]. ASN (FM&C) has ultimate responsibility for the budgeting function.



A uniquely Navy arrangement gives another title to the Director of Budget. In addition to his responsibility for the entire DON budget, he is also Director of the Fiscal Management Division (N82) and reports to the Deputy Chief of Naval Operations (Resources, Warfare Requirements and Assessment) (N8). In this capacity, he provides assistance to the Chief of Naval Operations in (1) ensuring that Navy programmatic needs are considered in developing DON financial management systems; (2) providing information and advice on the formulation, review, justification, and execution of the DON budget; (3) ensuring compliance with DON financial policy and procedures (Ref. 8, p. 12). Thus, N82 reports to both SECNAV and the CNO and OPNAV.

The budget expresses the financial requirements necessary to support and execute approved programs developed during the preceding planning and programming phases. The budgeting phase consists of two major steps: budget formulation and budget presentation and review.

**a. Budget Formulation**

The first step in the Budget Formulation phase is issuance of the Budget Guidance. The Budget Guidance consists of the following (Ref. 7, p. 138-139):

- DON Budget Guidance Manual (BGM) (NAVCOMPTINST 7102.2C/01 May 1995). The BGM is the authoritative source of information with respect to budget formulation and presentation of the DON budget. The primary purpose of the manual is to provide detailed guidance to budget submitting organizations for the preparation and submission of the budget estimates and preparation of requests for reconsideration in response to budget adjustments made by higher authority.

- **Budget Guidance Series**  
Notices published prior to each major budget submission and supplements the DON Budget Guidance Manual.
- **Memorandums**  
Specific budget review schedules and related guidance.
- **NAVCOMPT Manual, Volume 7 (Budgeting)**  
Directions for administration of appropriations and defines financial responsibilities.
- **NAVCOMPT Notices 7111**  
Supplements standard guidance and procedures contained in the DON Budget Guidance Manual (NAVCOMPTINST 7102.2C) including specific submission and review dates.

Budget Formulation essentially is the process of turning the POM into a budget. **Figure (19)** provides a comparison of the POM and budget highlights (Ref. 7, p. 141):

<b>POM</b>	<b>Budget</b>
Focus on major DON programs	Focus on each DON Program
Resources Sponsors	Budget Submitting Offices
Gross \$	More precise pricing
Program Decision Memorandum	President's Budget
By Mission	By Appropriation

**Figure 19** POM/Budget Comparison

Budget requests are prepared by **Budget Submitting Offices (BSOs)**. BSOs convert from program to appropriation categories. BSOs are major claimants and Program Offices that submit their budget estimates directly to the Navy Comptroller. BSOs are tasked to prepare estimates based on SECNAV programs as requested in the POM. The BSOs develop and submit budget estimates in conformance with the latest guidance, and ideally, the

current POM input. The POM, however, is not perfect. The BSOs are the first to feel its inadequacies and additional pressure is placed on the BSOs to fix "shortfalls and problems" in the POM.

**b. Budget Presentation and Review**

After budgets are prepared by Budget Submitting Offices, two reviews occur: (1) DON review and (2) Joint OSD/OMB review.

(1) DON Review: The Department of the Navy budget review compiles and transforms individual budgets of various offices within the Department into a "balanced" Departmental budget. It provides the Secretary of the Navy and senior advisors an opportunity for decision-making and control of the financial resources of the Department. Although it must conform to the policy, programmatic, and budgetary guidance of the Secretary of Defense, the budget is a statement of the DON priorities and contains the financial plan for achieving the Navy objectives. The key issue in budget review is the executability of programs, plans and activities within the fiscal year.

After receipt of the BSOs budget estimates, NAVCOMPT budget analysts conduct hearings to gather information to gain a greater understanding of the particular budget they are reviewing. NAVCOMPT analysts may have several programs to review and must have a thorough knowledge about program feasibility and executability. Analysts examine the submissions to ensure that they conform to the most recent guidance, are priced using the latest cost factors, and do not place resources at risk by allocating funds to

programs that may have changed since POM submission. Navy goals for budget review are to ensure: best pricing, best schedule, strong justification, requirement for fund availability during budget fiscal year, dollar and manpower balance, timely execution of funds and consistency. The budget must reflect changes driven by the POM, congressional reductions, PDMs and OMB/OSD fiscal guidance.

The next step in the DON budget formulation is a process unique to the DON. NAVCOMPT staff conducts a formal Markup and Reclama Review. The markups are recommended adjustments to programs in the budget estimates. The BSOs, Appropriation Sponsors and Resource Sponsors are given the opportunity to respond to markups through the Reclama process. If a claimant does not agree with a markup, it also submits a reclama. Required turnaround for reclamation is quick; only 24-48 hours. If no reclama is submitted, the mark is considered final. If a reclama is submitted, it is resolved at the lowest level at which an agreement can be reached. Since marks are signed by the NAVCOMPT division directors, the majority of disagreements are resolved at that level. If an issue cannot be resolved at the division director level, it is forwarded to the Director, Office of Budget (FMB). If the issue is not resolved at this level, FMB meets with the DCNO (Resources, Warfare Requirements and Assessment)(N8).

Upon completion of the mark and reclama review process, NAVCOMPT assembles the budget exhibits into a complete budget for

submission to the Secretary of the Navy for final approval. **Figure (20)** shows the general timeline of DON budget presentation and review. Once approved, the budget is submitted by SECNAV to OSD for the OSD/OMB budget review.

DON Budget Review Events	Timeframe
Budget Guidance is issued	April/May
Exhibits are prepared and submitted	May/July
Exhibits are reviewed and analyzed	July/August
Hearings are conducted	July/August
Marks are recommended	July/August
Reclamas are submitted and reviewed	July/August
Decisions are made	August
Meetings are held to resolve outstanding issues	August
SECNAV presentation	August
Approved DON budget is submitted to OSD	September

**Figure 20** DON Budget Review Schedule [After Ref. 7]

(2) OSD/OMB Budget Review: The OSD/OMB budget review cycle is very similar to the DON budget review. **Figure (21)** outlines the OSD/OMB budget review cycle.

The joint budget review conducted by the Office of the Secretary of Defense and Office of Management and Budget (OMB) transforms the DON budget into part of the DOD budget and then into part of the President's Budget. This review provides the final control and decision-making opportunities for both the SECDEF and the President, prior to submission of the budget to Congress.

<b>OSD/OMB Budget Review Events</b>	<b>Timeframe</b>
Budget Guidance is issued	August
Exhibits are prepared and submitted	September
Exhibits are reviewed and analyzed	Sept/Oct
Hearings are conducted	Sept/Oct
PBDs/DMRDs are recommended	Oct/Dec
Reclamas are submitted and reviewed	Oct/Dec
Decisions are made	Nov/Dec
MBI meetings are held to resolve issues	Nov/Dec
SECDEF discussion with President	December
Approved budget submitted as Pres Budget	February

**Figure 21** OSD/OMB Budget Review Schedule [After Ref. 7]

SECDEF holds a series of budget hearings jointly with OMB on the DOD component requests. These hearings are used by SECDEF to formulate his Program Budget Decisions (PBDs) and Defense Management Report Decisions (DMRDs). PBDs are similar to the PDM issues in that they provide alternatives to the service proposals. DMRDs seek to achieve economies and efficiencies through management reform in one of three ways: changes in business practices (e.g., Defense Business Operations Fund - DBOF); consolidation efforts (e.g., Supply Centers); or changes in management practices (e.g., reduction of SECNAV staff) (Ref. 7, p. 150).

In the Department of the Navy, responses to PBDs are coordinated by the FMB. Draft copies of PBDs are circulated to the services the same time they are given to OSD so that most issues may be resolved before

the PBDs are signed. The OSD reclama process differs from the Navy review in that all responses are written and there are no face-to-face hearings. Despite that, the reclama process still gives the departments and military services an opportunity to appeal a decision by the Office of Secretary of Defense. Once a PBD is signed, it is incorporated into the Budget Estimate Submission (BES) for inclusion in the President's Budget. The military departments have one last opportunity to appeal decisions made by PBDs. The appeal is made in the Major Budget Issue (MBI) series. MBIs are issues that the services deem vitally important to their effective operation. These issues are briefed to the DPRB by the service secretaries and chiefs. They are then decided upon by SECDEF and DEPSECDEF. The DOD budgeting phase is completed when the President sends his budget (with DOD input) to Congress in February each year.

### III. PRINCIPLES OF REENGINEERING

#### A. INTRODUCTION

In the last six years, "Business Process Reengineering" (BPR) or, more commonly, just "Reengineering" has emerged as a significant management movement. Its basic concept is simple: revolutionary advances in business processes and information technology make possible comprehensive changes in the way companies operate, resulting in quantum improvements in efficiencies and effectiveness (Ref. 28, pp. 104-112).

The foundation principles of modern organizations were established over two hundred years ago by, among others, Adam Smith in his book, *The Wealth of Nations*. Recognizing that the technology of the industrial revolution had created unprecedented opportunities for manufacturers to increase worker productivity, Smith developed a principle based on the premise that work should be broken down into component tasks. The principle, known as the division of labor, achieved its efficiency by reducing even the most complex assignments into a series of minute tasks, tasks that are easily understood and performed by the workforce. When the tasks are combined the resulting productivity was orders of magnitude higher. However, to link these simplistic tasks, complex processes had to be developed. The result of centuries of this style of business practice is a multi-layered organization comprised of divisions that, as a result of their decentralization, may not hold consistent objectives with regards to the organization as a whole. Today, overlapping and redundant features within



divisional organizations create significant cost and quality inefficiencies. (Ref. 29, pp. 11-13) In a *Harvard Business Review* article, "Reengineering Work: Don't Automate, Obliterate (1990)" Michael Hammer states, "It should come as no surprise that our business processes and structures are outmoded and obsolete: our work structures and processes have not kept pace with the changes in technology, demographics, and business objectives" (Ref. 28, p. 107).

Reengineering seeks to collapse traditional organizational boundaries and develop streamlined, efficient processes that meet the demands of markets and customers. Reengineering proposes a new principle: that the design of work must be based not on hierarchical organization and the specialization of labor but on work processes and the creation of value for the customer (Ref. 29, p. 11).

While the concept of reengineering is not the sole product of any one or group of individuals, Michael Hammer's article in the *Harvard Business Review*, "Reengineering Work: Don't Automate, Obliterate (1990)" and a subsequent book by Hammer and James Champy, *Reengineering the Corporation: A Manifesto for Business Revolution* (1993), catapulted reengineering to the forefront of contemporary management techniques.

## B. REENGINEERING DEFINITION

Hammer and Champy define reengineering as:

**... the fundamental rethinking and radical redesign of business processes to achieve dramatic improvements in performance**  
(Ref. 30, p. 32).

In its purest sense, reengineering means starting over. It means wiping the slate clean and beginning anew. It means starting from scratch in designing core business processes, not spending months analyzing and refining current ones. Reengineering does not include tinkering with what already exists or making incremental changes that leave basic structures intact. It is not about making patchwork fixes and jury-rigging existing systems so that they work better. Reengineering means tossing aside old systems and starting over. It involves going back to the beginning and inventing a better way of doing work. It means pretending that no systems or procedures are in place, and asking, "If we were recreating this today, what would it look like?" Hammer writes, "At the heart of reengineering is the notion of discontinuous thinking—of recognizing and breaking away from the fundamental assumptions that underlie operations" (Ref. 28, p. 107).

In the definition of reengineering by Hammer and Champy, the words "radical," "redesign," "processes" and "dramatic" are key to its understanding.

Each signifies important implications for managers seeking to employ

Reengineering to improve their organizations:

- **Radical:** Comes from the Latin word meaning root. Reengineering is not about improving what already exists. Rather it is about throwing it away and starting over. Once the traditional processes are understood and improved processes are recognized, radical change must be implemented to effectively root out the old and usher in the new.
- **Redesign:** Reengineering is about the design of how work is done. Reengineering is based on the premise that the design of work processes is of essential importance.
- **Dramatic:** Organizations that adopt Reengineering to effect process change should do so with the expectation that quantum leaps in performance will be achieved. These dramatic results differ significantly from the incremental (e.g. 10%) improvements sought by organizations involved in improving old processes.
- **Processes:** Work processes are reengineered not departments. This simple statement is critical. It makes no sense to claim to reengineer a department. Reengineering changes how work is done, across traditional units like departments. Processes are the activities that take an input and create an output that is of value to the customer. Processes are where the improvements are effected in order to improve an organization's operation. (Ref. 30, pp. 32-36)

### C. REENGINEERING PRINCIPLES

In his landmark 1990 article, Michael Hammer presented the following seven principles of reengineering:

1. Organize around outcomes, not tasks.
2. Have those that use the output perform the process.
3. Subsume information-processing work into the real work that produces the information.
4. Treat geographically dispersed resources as though they were centralized.
5. Link parallel activities instead of integrating their results.
6. Put the decision point where the work is performed.
7. Capture information at its source. (Ref. 28, pp.106-112)

As Hammer points out , “reengineering need not be haphazard” (Ref. 28, p. 108). While all seven principles may not pertain to every organization, many organizations are already applying a number of these principles in their reengineering efforts.

Hammer and Champy’s 1993 book provides a deeper analysis of the characteristics that typify the reengineering process (Ref. 30, pp. 50-64).

- *Several jobs are combined into one.* The most basic and common feature of reengineering is the absence of assembly line mentality. Many formally distinct jobs or tasks are integrated and compressed, eliminating the need for specialists. “Case teams” are constructed to perform the entire process and are given total responsibility for its implementation. The payoffs of the

integrated process and case teams approach is substantial. Elimination of “handoffs” increases process speed while reducing errors and rework. By omitting the requirement to develop complex procedures that were previously required to adequately link inter-divisional tasks, administrative overhead is reduced. Improved control is another benefit of these integrated processes; because they involve fewer people, assigning responsibility for them and monitoring performance is easier.

- *Workers make decisions.* Corporations that undertake reengineering not only compress processes horizontally but also rely on workers within the “trenches” to develop alternative measures to become more efficient. Thus, the process is also compressed vertically as workers are empowered to make their own decisions. Although this transfers control away from executives and supervisors of the hierarchical model, more creative, innovative ideas result from those who are aware of the process and have “hands on” practical experience. The blind reliance on “isolated” executives to make appropriate decisions often has led to inferior resource allocation and program implementation choices.

- *The steps in the process are performed in a natural order.*

Reengineered processes are not confined to the traditional straightline sequence inherent in linear, sequential processes. Reengineering is focused on turning “sequential” processes into “parallel” ones. Sequential processes are abundant in bureaucracies: Clerk A finishes her work on a case before turning over the paperwork to Clerk B, who finishes his work before turning it over to

Auditor C. Parallel processes are what a reengineered bureaucracy is all about: Clerk A, Clerk B, and Auditor C work on the case simultaneously. Or even better, Clerk A, whose title is now "Case Manager" handles it from start to finish. Either way, the big payoff comes in eliminating the disconnects that are inevitable with the "handoffs" associated with a sequential process and reduces the amount of time between the early and late steps of a process enabling work to be completed quicker.

- *Processes have multiple versions.* Traditional processes were intended to provide mass production for the mass market. Inputs were reduced to the most simplistic aspect and standardized so as to achieve uniformity. However, this logic is obsolete as it relates to the diversity associated with today's consumer environment. Reengineering allows individuals to tailor the process to meet unique requirements derived from the situations and circumstances at hand. Traditional "one-size-fits-all" processes increase complexity in that they must incorporate special procedures and exceptions to handle a wide range of situations. In contrast, reengineering maintains a simplistic process because each version is only required to handle the case for which it is appropriate.

- *Work is performed where it makes the most sense.* Reengineering allows the shifting of work across organizational boundaries, contrary to traditional methods or business practices. The result is a significant cost reduction by reducing and some cases eliminating "specialists" as well as the reduced time and errors associated with interdepartmental transfers. Work is

shifted across organizational boundaries to improve overall process performance.

- *Checks and controls are reduced.* Reengineered processes use controls only to the extent they make economic sense. The controls will, by design, tolerate modest or limited abuse, but will more than compensate by dramatically lowering the time and costs associated with the control itself. A well-designed process, utilizing reengineering techniques, reduces the number of jobs, reduces the number of inter-departmental transactions, allows "team" members to continually evaluate the process and ultimately reduces the need for audits and checks. The goal is not to design a flawless inspection process, but to design one that will meet the necessities of a logical audit trail while providing a simple, cost-effective method that will get the job done.

- *Hybrid centralized/decentralized operations are prevalent.*

Reengineering allows combination of the advantages of centralization and decentralization. Information technology enables individual divisions to act autonomously, yet still enjoy the economy of scale that centralization creates.

Reengineering differs from Total Quality Management (TQM) in that TQM programs seek continuous incremental improvement working within the framework of existing processes where Reengineering seeks breakthroughs by changing existing processes. A breakdown of the major differences between Reengineering and TQM is exhibited in **Table 1**.

	<b>TQM</b>	<b>BPR</b>
<b>Level of Change</b>	<b>Incremental</b>	<b>Radical</b>
<b>Starting Point</b>	<b>Existing process</b>	<b>Clean slate</b>
<b>Frequency of Change</b>	<b>Continuous</b>	<b>One-time</b>
<b>Time Required</b>	<b>Short</b>	<b>Long</b>
<b>Participation</b>	<b>Bottom-up</b>	<b>Top-down</b>
<b>Typical Scope</b>	<b>Narrow, within functions</b>	<b>Broad, cross-functional</b>
<b>Risk</b>	<b>Moderate</b>	<b>High</b>
<b>Primary Enabler</b>	<b>Statistical control</b>	<b>Information Technology</b>
<b>Type of Change</b>	<b>Cultural</b>	<b>Cultural/Structural</b>

**Table 1. TQM vs. BPR**

[After Ref. 31]

#### **D. IMPLEMENTING REENGINEERING**

Reengineering is a top-down process. Participation by senior executives is required to initiate and implement a successful reengineering effort. Senior managers possess the broad perspective to see the process as a whole and to recognize its poor overall design as the source of their problems. Additionally, business processes cross organizational boundaries, so no mid-level manager will have sufficient authority to transform a process. Radical change proposed by reengineering threatens the status quo and requires senior management leadership to focus on improving process orientation without regards to individual turf or ownership "rice bowls." Hammer and Champy (1993) state:

**Reengineering, in contrast (to TQM), is an intensive, top-down vision-driven effort that requires nonstop senior management participation and support.**

(Ref. 30, p. 219)



As a result of its own reengineering program, AT&T identified four steps to implementing a successful program (Ref. 32, pp. 1-73). The first step is to evaluate the benefits, costs and risks. The primary activity for this step is to evaluate the feasibility of a reengineering project based on expected benefits, risks, and the environment. The deliverables for this step are the decision to begin, the charter for the reengineering team, and a strategy for change management.

The second step in reengineering is to recommend a concept for a redesigned process. The primary activity for this step is to develop and evaluate concepts for a new process design based on customer requirements, benchmarking and innovative ideas. The deliverables for this step are innovative ideas, high-level flowcharts, estimated requirements, preliminary feasibility analysis, and the decision to continue.

The third step is to design the process. The primary activity for this step is to develop and evaluate the detailed design. The deliverables for this step are detailed flowcharts, process measures, prediction models, final feasibility analysis, and the decision to implement the redesigned process.

The fourth step is to implement the process. The primary activity for this step is to develop the final implementation plan and select the cutover strategy. The deliverables for this step are the implementation plan, plan for organizational redesign, implementation of change management plan and a redesigned process that is continuously managed.

Implementation of reengineering should not be seen as a quick fix. It is a hard, gut-wrenching, time-consuming process. It is unprecedented in its attempt to completely reinvent the basic aspects of organizations. There are many reasons for failure but most can be attributed to individuals who do not approach reengineering by applying its basic principles and do not understand the basic processes of their own organization. Hammer and Stanton (1995) list the top ten ways to fail at reengineering (Ref. 29, pp. 14-33):

1. Don't reengineer but say that you are.
2. Don't focus on processes.
3. Spend a lot of time analyzing the current situation.
4. Proceed without strong executive leadership.
5. Be timid in redesign.
6. Go directly from conceptual design to implementation.
7. Reengineer slowly.
8. Place some aspects of the business off-limits.
9. Adopt a conventional implementation style.
10. Ignore the concerns of your people.

#### **E. REENGINEERING GOVERNMENT**

The pressures for reengineering are just as intense in the public sector where shrinking budgets and public pressure for reform necessitate a change in the "business as usual" approach. One unique challenge to reengineering in the

public sector is the difficulty of measuring performance. Private sector organizations can use profit as a yardstick of success, and profit is linked to costs, or by increasing quality and service, therefore driving up revenues. The bottom line represents a simple way of telling whether the business is improving or not. Most public sector institutions, however, have only a cost line (even then good cost data is not always available), which makes it hard to assess tradeoffs between improving services and reducing costs.

A second difficulty is that breaking down departmental barriers within a corporation is much easier than breaking them down between or within government agencies.

Reengineering in the government, as in the private sector, is painful and risky. Preparation is required to improve the chances of successful implementation. Preparation includes:

- Shaping a vision and infrastructure to support it.
- Educating managers on the opportunities and process of reengineering.
- Finding creative sources of funding.
- Benchmarking performance and making the measures visible.

- *Shaping a vision and infrastructure to support it.* Reengineering requires a leap from the well-understood status quo. Proposals to reengineer will not gain adequate support unless people can share a motivating vision of success. The vision should emphasize purposes, behavior, performance criteria, decision rules, and standards that serve the public rather than the organization (Ref. 33, p. 156).

- *Educating managers on the opportunities and process of reengineering.*

Reengineering requires cooperation between information technology managers, program managers, and senior leadership. Educating these managers and building cooperative relationships among them is an essential part of building the infrastructure for successful reengineering.

- *Finding creative sources of funding.* Funding projects in reengineering can be a large issues especially for the government. Discretionary funds are under tremendous budget pressure. Innovative sources must be established to fund the reengineering process. Examples of potential methods for saving money include: sharing savings among stakeholders involved in reengineering efforts (i.e. department budgets, civilian workers), or, developing public/private ventures that could be funded in part by private firms.

- *Benchmarking performance and making the measures visible.* In past government practices little has been done to measure service performance. It is time to measure government performance against world-class performers where applicable. Measures such as customer service, overhead costs, and worker ratios can be evaluated against industry standards. (Ref. 34, pp. 51-53)

In his book *The Reengineering Revolution: A Handbook* (1995) Hammer refers to organizations, including the federal government, that are not primarily motivated by the “bottomline” as **mission-driven** organizations (Ref. 29, pp. 274-290). He provides four precepts for reengineering mission-driven organizations:

- Carefully identify and understand customers.
- Clearly specify performance measures.
- Be sensitive to the concerns of idealists in the organization.
- Deflect those who use the mission as a smokescreen for resistance.

Few public sector reengineering projects have been around long enough to have much of a track record. The Clinton administration’s National Performance Review (NPR) and U.S. Army Forces Command (FORSCOM) are two examples of notable government reengineering efforts. The National Performance Review is an attempt by the White House under the direct supervision of Vice President Gore to utilize reengineering principles to cut government bureaucracy and waste and improve performance standards (Ref. 35, p. 19). The U.S. Army Forces Command (FORSCOM) has committed to reengineering to improve the command’s business practices to create the most efficient organization possible. The goal is to transform itself from an “industrial age fighting force into one firmly founded on digitized information age technology, which creates faster, more effective battlefield communications.” (Ref. 36, pp. 31-34)

DOD published guidance on Business Process Reengineering is contained primarily in three documents: *DOD 8020.1-M, Interim Management Guidance on Functional Process Improvement; Corporate Information Management: Process Improvement for DOD Managers*; and, *Framework For Managing Process Improvement: A Guide to the Methodology* (Refs. 37; 38; 39). The primary purpose of these documents is to apply the theoretical concepts of reengineering into a practical model that can be applied to organizational processes within the DOD.

#### **F. SUMMARY**

This chapter introduced Reengineering as a management approach to the fundamental redesign of business processes. Although similarities exist between reengineering and other initiatives, the significant difference is that reengineering seeks to radically change work processes to achieve large improvements rather than implementing incremental changes to existing processes to achieve marginal improvements.

While governments have lagged behind the private sector in embracing reengineering, the opportunities to successfully achieve significant performance gains by applying reengineering precepts do exist. Wherever there are work processes, whether public or private, the principles of reengineering can be applied.



## **IV. REENGINEERING THE NAVY POM AND PPBS PROCESSES**

### **A. INTRODUCTION**

Organizational structure and resource allocation processes within DOD have been under constant scrutiny and revision since the end of World War II. The National Security Act of 1947 was the product of Congressional compromise that attempted to accommodate two fundamentally incompatible approaches to how the DOD should be organized and how the nation's defense policies should best be formulated and implemented: it sought to structure a defense organization that would be unified, yet retain Service autonomy. The 1947 Act established a Secretary of Defense to act as "the principal assistant to the President in all matters relating to national security" while at the same time providing that "nothing herein shall prevent the Secretary of the Army, Secretary of the Navy, or Secretary of the Air Force from presenting to the President . . . any report or recommendation relating to his department which he may deem necessary" (Ref. 40).

The 1948 Key West Agreement was the product of a meeting convened by the first Secretary of Defense, James Forrestal, to work out disagreements among the Services sparked by the National Security Act of 1947. The agreement sought to limit interservice competition by confirming the traditional functional boundaries of the military departments (Ref. 41, p. 47). Formal allocation of roles and functions was intended to prevent unnecessary



duplication. However, instead of promoting jointness, the military departments and services sought to preserve as much of their independence as possible.

In 1949 an amendment to the National Security Act of 1947 strengthened the authority of SECDEF and took away the right of the Services to submit their budgets directly to the President. The amendment also established a Chairman for the JCS (Ref. 42).

The Defense Reorganization Act of 1958 granted SECDEF broad statutory authority that has continued to date, including the authority to transfer, consolidate and abolish the functions and roles of the military services. The 1958 Act gave the Defense Secretary the statutory authority to exert centralized control over the Services through the budgetary process. Further, the 1958 Act gave the Secretary the power to establish unified and specified commands, and it put the operational control of those commands in the hands of the Defense Secretary (Ref. 43). In 1962, Secretary of Defense Robert McNamara utilized this broad power vested in the DOD civilian leadership to implement a technically-oriented resource management system based on system analysis: PPBS. For McNamara, the way to coordinate strategy was to decentralize much of the execution of the budget while centralizing the decision-making process for defense policy, i.e., planning and programming.

The Goldwater-Nichols Department of Defense Reorganization Act of 1986 was designed to correct the perceived weaknesses in the defense organizational structure established in 1947 by further centralizing defense

decision-making within the JCS. One of its major provisions was to require CJCS to review Service budget proposals and advise SECDEF as to their impact on the unified and specified commands (Ref. 10).

These various initiatives to define the defense organization and resource allocation processes clearly demonstrate what has plagued and frustrated defense reformers since the end of WWII: (1) how best to structure the American defense organization to meet the goals of developing and implementing long-range, coordinated plans and policies; and; (2) how to establish the proper link between national security policy and the roles and missions of the military services.

The FY 94 Defense Authorization Act created the *Commission on Roles and Missions of the Armed Forces* to "review . . . the appropriateness . . . of current allocations of roles, missions, and functions among the Armed Forces; evaluate and report on alternative allocations; and make recommendations for changes in the current definition and distribution of those roles, missions and functions" (Ref. 44). The Commission breaks from the traditional approach to roles and missions, i.e., attempting to allocate them among the Services in context of the Key West Agreement, and champions the call for greater emphasis on unified military operations while affirming the necessity of "broad" Service competition (Ref. 45, p. ES-3).

Recognition of the broader structural and historical problems faced by DOD is important when proposing changes to any part of it. PPBS is no

exception. Changes in the method DOD employs for resource allocation will reverberate throughout its organizational structure. DOD budget and program decisions are key to the architecture of the Defense Department because those decisions often result in the de facto allocation of roles, missions and functions. (Ref. 45, p. ES-7) As a seasoned NAVCOMPT analyst noted, "Budget is policy."

This chapter will analyze three possible frameworks within which DOD resource allocation and, in particular, Navy POM and PPBS processes, may be reengineered to achieve greater efficiency and effectiveness. Although each method varies in degree of change from incremental to more radical, each offers systemic changes to the current process. Their effect on the architecture of the Defense Department is outlined here.

## **B. STRATEGY-TO-TASKS**

### **1. Description**

The following description is based on a RAND study by Leslie Lewis and C. Robert Roll, *Strategy-to-Tasks: A Methodology for Resource Allocation and Management* (1993). The strategy-to-tasks framework is intended to make PPBS more rational and credible by linking high-level strategic goals to tasks performed by the various participants in PPBS. The linkages, defined by the methodology, are intended to help the participants in the PPBS process to interact more effectively. (Ref. 46, p. 1)

Strategy-to-tasks provides decision-makers with an end-to-end concept of operations. It links resource decisions to specific military tasks that require resources which, in turn, are linked downward hierarchically from higher-level operational and national security strategies to supporting programs and tasks. Likewise, resource decisions can be linked upward from tasks up through strategies. **Figure (22)** illustrates the hierarchal linkages of the Strategy-to-Tasks methodology:

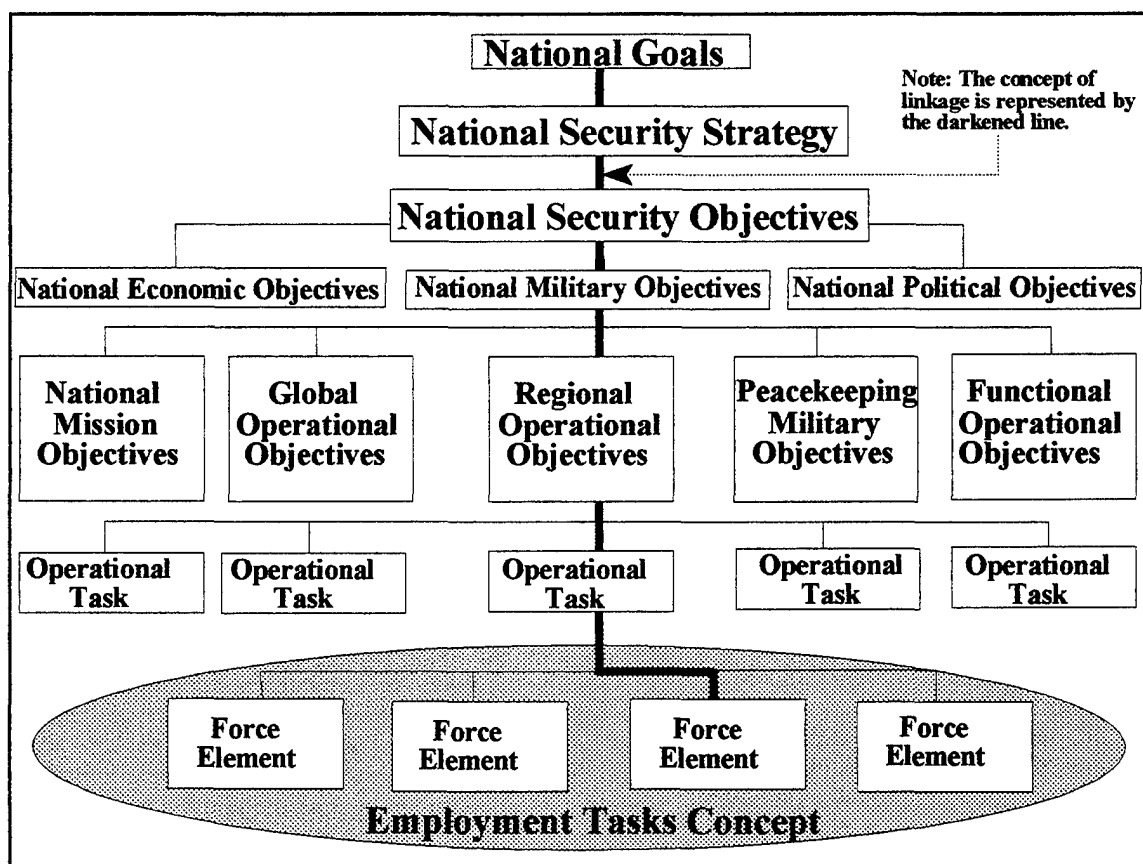

**Figure 22** Strategy-to-Tasks Hierarchy of Linkages [After Ref. 46]

Using the national military strategy, developed from the national security strategy, specific military objectives may be clearly identified. The National Military Strategy of 1995 states the national military objectives as: (1) promote stability, (2) to thwart aggression. Within these military objectives a definition is provided on how the U.S. national security strategy will be supported militarily and how the U.S. will respond to threats to its national security. Military objectives should fold into the strategic concepts in the National Military Strategy -- overseas presence and power projection -- and its components -- peacetime engagement, deterrence and conflict prevention, and fighting and winning wars.

The next consideration is operational objectives. Operational objectives define various military strategies. They describe how forces are to be used to support national military objectives. They represent the CINC's vision and strategic perspective on how the various assets support national military objectives and national security objectives. Operational objectives are the link between higher-level national security and military objectives and mission-specific operations, and the resources that support those operations.

Operational tasks define the next level of the hierarchy. Tasks are formulated by the CINCs. They are specific actions that must be performed to accomplish an operational objective. Each task is defined by an operational concept. An operational concept weaves together the various systems, organizations, and tactics needed to accomplish a particular task. Operational tasks support operational objectives.

Employment tasks are actions that must be performed in support of operational tasks. An individual employment task may contribute to more than one operational task, and in turn, an operational task may support more than one operational objective. Force elements are groups of resources (personnel, training and equipment) needed to perform an employment task. Because many different types of force elements can be used to support a task, decision makers must choose the resource combinations that are most cost effective in accomplishing a task.

Using the strategy-to-tasks framework, DOD could evaluate its force structure and the modernization programs of the Services by operational objective and task. DOD leadership would decide system funding based on its necessity in providing capabilities to multiple mission areas, or to those that are unique but necessary to support a particular mission. Strategy-to-Tasks works within the current PPBS process and is supportive of each of its phases.

The objective of Strategy-to-Tasks is to provide a basis for evaluating alternative programs that potentially could meet warfighting needs and then to establish and justify resource priorities within the context of the national security strategy.

## **2. Application to Navy POM and PPBS Processes**

The design of current Navy POM and PPBS processes closely resembles the strategy-to-tasks methodology. The Joint Mission Area/Support Area (JMA/SA) assessments completed at the outset of the Programming phase are

aimed at ensuring naval forces match national security requirements and contribute to joint force capabilities. The subsequent Investment Balance Review (IBR) attempts to forge the assessment results into a consensus investment strategy matching fiscal resources with required capabilities. This process strives to ensure that Navy programs address warfighting requirements, are properly funded, and are balanced across all warfare and support areas.

However, several systemic problems within the Navy PPBS process inhibit the linkage between strategy and tasks. First, failure to encourage "out-of-the-box" thinking in the JMA/SA assessment process tends to produce a "scaled-down" version of today's Navy rather than the smaller, more flexible force envisioned in the Navy white paper *Forward...From the Sea* (Ref.17, p. 55). Instead of cutting across the concerns of traditional platform and warfare areas, the JMA/SA assessments reflect the parochial interests of the resource sponsors who supervise them (Ref. 16, p. 17).

Second, the current IBR structure does not produce clear guidance for upcoming POM development. Neither SECNAV's DON Programming Guidance or N80's Preliminary Programming Guidance fully incorporates the outcome of the IBR. National security issues and joint planning requirements covered in excruciating detail during the JMA/SAs are not given complete consideration by Programmers. Without clear guidance at the beginning of POM development, traditional OPNAV power players (i.e., Resource Sponsors) at present have the

opportunity to exert their parochial biases on POM development, potentially at the expense of strategic programs (Ref. 16, pp. 39-41).

Third, the JMA/SA assessments fail to develop an adequate understanding of what resources the Army or Air Force could apply to a given mission area so that Navy needs and capabilities in the same mission area might be compared and traded off with the contributions of other services (Ref. 25, pp. 33-38). An example is the assessment of Navy strike capabilities compared to Air Force strike capabilities. Failure to identify redundant naval capabilities or resources that could be reduced with minimal degradation to the nation's security and then to apply savings to other naval programs can produce cost-inefficient results during the OSD "end game" review. Better organizational incentives are needed to allow military Department Secretaries to retain savings generated from identifying duplicative or unnecessary capabilities in their future "top line," and to encourage innovative thinking to the benefit of the entire Department of Defense.

## **C. MISSION-BASED RESOURCE ALLOCATION**

### **1. Description**

The following description is based in part on the work of L.R. Jones and G.C. Bixler in their book, *Mission Financing to Realign National Defense* (1992).

Contemporary management philosophy asserts that the effectiveness of large, complex organizations improves when authority and responsibility are



delegated down into the organization. Within the present DOD system, influence over resource allocation is overwhelmingly with Congress, OSD and military services and not with the operational commands. Under a mission-based methodology for resource allocation, the responsibility for operations and procurement, resources definition and budget execution would be placed at the command level, where military commanders (i.e., CINCs) could utilize their expertise to make resource allocation and mission tradeoffs. Corporate experience shows the value of putting responsibility and authority into the hands of those responsible for the "mission." Decisions are made where the work is completed. The benefits of compressing the decision-making process vertically, i.e., down to the individuals closest to the "mission," include better efficiency, fewer mistakes and rework, lower overhead and greater empowerment of the workers (Ref. 30, p. 53).

The preeminence of the Unified CINCs in implementing the national military strategy to support the national security strategy is now well entrenched in U.S. defense guidance, if not fully in the collective psyche of the uniformed services. The Commission on Roles and Missions reported, "We reaffirm the role of the CINCs that has evolved in law and in practice: CINCs are responsible

for fighting America's wars and employing military forces in pursuit of national security objectives." They go on to say,

**The central message . . . is in the 21st century, every DOD element must focus on supporting the operations of the Unified Commanders in Chief (CINCs). Everything DOD does --from furnishing health care to developing new weapons--should support that effort (Ref. 45, p. ES-1).**

These statements reflect the fact that combatant commands should be understood to be the principal instruments for execution of U.S. defense policy.

In a mission-based resource allocation structure, most of the Defense Department budget would be allocated directly to the unified and specified commands, or alternatively to the individual Service CINCs. The basic assumption supporting this approach is that military commanders know best what types of operations, hardware, facilities and equipment are needed to deter threat and to engage in war when required. Further, it is assumed that they are better able to take advantage of efficiencies related to the utilization of the private sector, especially in support areas, than similar initiatives controlled and managed by the Pentagon and Congress. The four services would compete to provide forces, weapons and supplies to the Unified commands. Military Departments would maintain their Title X prerogatives to organize, train and equip their combat and supporting forces but in conformance with CINC requirements.

The mission approach criticizes the present system for inhibiting innovation and efficiency primarily because it operates under a centralized,

command-control framework rather than according to market-based principles that would result in greater efficiency (Ref. 47, p. 215). Under mission-based methodology, competition among the services would provide that market-base. No service could purposely "over-price" its capabilities because the overlapping abilities of the other services would provide a substitutable force. The architecture of the force, its configuration and application would become the province of force commanders (the CINCs), rather than the "supplying" department or agency.

The role of OSD as well as the service secretaries would be similar to what it is now, that is, to communicate decisions on policy and commitments from Congress, the President, SECDEF and JCS to the military commanders and to exercise centralized budget rationing authority. Commitments and national security objectives still would be determined by Congress and the President, but decisions on operating and support spending to execute the national military strategy would be made at the command level with far more authority delegated to military commanders than is the case presently. The focus of the planning process would be on mission outputs. The financial role of policy makers would be to specify, in general, how much money should be spent attempting to achieve major national security goals by command and mission area. In this way, resource priorities by mission and mission area or geographical region would have to be defined more clearly. Further, the costs to support discrete missions by region or area would be more clearly identified.

Such information would aid benefit/cost and benefit/risk analysis for alternative uses of resources. Priorities could be linked more clearly to resource decisions.

Adoption of mission-based budgeting would eliminate the necessity for centralized preparation of the POM in the programming component in PPBS. While the basic PPBS process would be retained, programming would be a function performed by the CINCs as would budget formulation. Planning, programming and budgeting for the DOD could be analyzed according to mission areas, e.g., Atlantic forces, Pacific forces, strategic forces, and contingency forces. The full DOD budget could be appropriated in a mission format by adding one more mission component (management support forces) to cover the costs of operating the Pentagon and other Pentagon-based management support activities (Ref. 47, p. 213). Under the mission-based approach, budgets would be proposed by the CINCs, reviewed according to criteria established by OSD and the military departments, proposed to and then appropriated by Congress. The transfer of funds to command budgets for execution would be straight-forward following the resource decisions negotiated between Congress and the President. In this regard mission budgeting is essentially the same as the existing process. However, by placing greater authority with the war fighting CINCs the presumption is that such a delegation could lead to less micromanagement of the Defense Department and defense budget by Congress. Whether this would result is a political question rather than a management issue.

The basic tenets of the mission-based resource allocation methodology have long history of support by Pentagon reformers: Secretary of Defense Weinberger (1982), Packard Commission (1986), Goldwater-Nichols (1986), U.S. Senate Armed Services Committee/House Armed Services Committee (1990), CJCS Powell's Base Force (1991) and the Commission on Roles and Missions (1995). These initiatives have recognized that implementation of a mission-based methodology would better align existing DOD management and mission control structures, eliminate unnecessary procedural complexity, cut the size of the decision system to what is needed to operate more efficiently, and to better utilize the expertise of the private sector. The Commission on Roles and Missions asserted, "The CINCs must have greater influence over the processes and priorities used to acquire the weapons, equipment, and forces they need to accomplish their warfighting and other missions . . ." (Ref. 45, p. 2-1).

Mission-based budgeting would provide this influence but would require substantial delegation of authority. In turn, it would provide more accountability by relating mission capability by area or region more directly to the policy priorities established by elected officials. Mission-based budgeting would assess and allocate resources on the basis of threat, commitments, desired outcomes, and national security priorities. It would emphasize the importance of policy to guide budgets rather than having budgets drive policy.

Responsibility for resource decision-making, allocation, and management described in the mission-based methodology above can ultimately be given to

Unified commanders or to the military service commands. However, Jones and Bixler conclude that it would be more effective to place the programming and budgeting responsibilities with the service mission area commands, that is, Commander in Chief U.S. Army Europe; Commander in Chief U.S. Air Forces Pacific, Commander in Chief U.S. Atlantic Fleet; etc. These regional service commanders are the best qualified because they are specialists in the warfare mission areas in which their services operate. Their specialized experience and close proximity to the fighting forces improve their ability to make optimum resource decisions.

## **2. Application to Navy POM and PPBS Processes**

Mission-based budgeting would radically change current Navy POM and PPBS processes. The current process requires that a POM and budget be produced by different organizations, resulting in a somewhat disjointed decision-making apparatus. Although the CINCs, component commanders and claimants provide input for the POM they do not directly engage in its development. CINC input is provided in issues submitted as CINC Maritime concerns prior to JMA/SA assessments and CINC IPLs submitted prior to the IBR. Means for Component Commanders to influence POM development is through Component Issue Papers (CIPs) where their program and budget requirements, prioritized by Unified CINC IPLs, must be addressed by Resource Sponsors in SPPDs. Claimants submit their major programmatic concerns in the form of issue papers to the OPNAV staff. Resource Sponsors consider these concerns as they

develop Sponsor Program Proposals. While this process serves to enter CINC/Component Commander requirements into POM deliberations it does not ensure their eventual funding. OPNAV program managers are judged on the basis of how successful they are in getting parochial service requirements funded, built and operational, not on their skill in introducing a joint perspective to the process in which the services make decisions about what they need (Ref. 48, p. 10). The centralized nature of POM development in the current process limits CINC/Component Commander direct influence on programmatic choices.

While the field activities and claimants do participate directly in budget development, they have little flexibility to address additional program requirements identified by the CINCs/Component Commanders. Budget estimates and exhibits are required to reflect programs contained in the POM (Ref. 19, p. 1-35). Executability problems in the POM restrict the ability of claimants to match resource dollars with resource requirements. This forces continual rework by budget personnel to ensure funds are not wasted or lost. Archaic appropriation rules established by a micro-managing Congress also make it difficult for claimants to move resources when necessary to manage more efficiently.

Mission-based budgeting would eliminate separate POM and budgeting responsibilities, combining them under the responsibility of the CINCs. It is important to note that the basic tasks of programming would be retained and still performed, but in a much less complicated process and folded into budgeting.

This may be viewed as long-range budgeting similar to practices employed in the private sector. CINCs/Component Commanders/Claimants could more effectively allocate resources to achieve program objectives because they would be more focused on execution. Resource Sponsors could still play an oversight role to ensure claimant allocations meet sponsor priorities. However, the necessity for employing a large, centralized Navy headquarters staff as currently exists to do the POM would be gone. The Investment Balance Review could pass program/budget controls directly to claimants vice Resource Sponsors. CINCs/Component Commanders/Claimants would have the lead in program formulation and would continue to be responsible for budget formulation. The entire process would not be redundant and disjointed as is the case presently. Navy headquarters would still retain control over some parts of the budget, particularly major acquisition and force structure decisions. **Figure (23)** illustrates one approach to program development under the mission-based process.

Claimants would submit budgets with elements of the POM, as it is presently prepared, embedded in them. SECNAV would hold an integrated POM/budget review. At that time claimants could explain Service program objectives that are deemed "unaffordable". The major benefit of this type of system is in having claimants gain greater control over their resources. Since the claimants are more focused on execution, they can allocate resources to achieve program objectives more directly. OPNAV sponsors would have



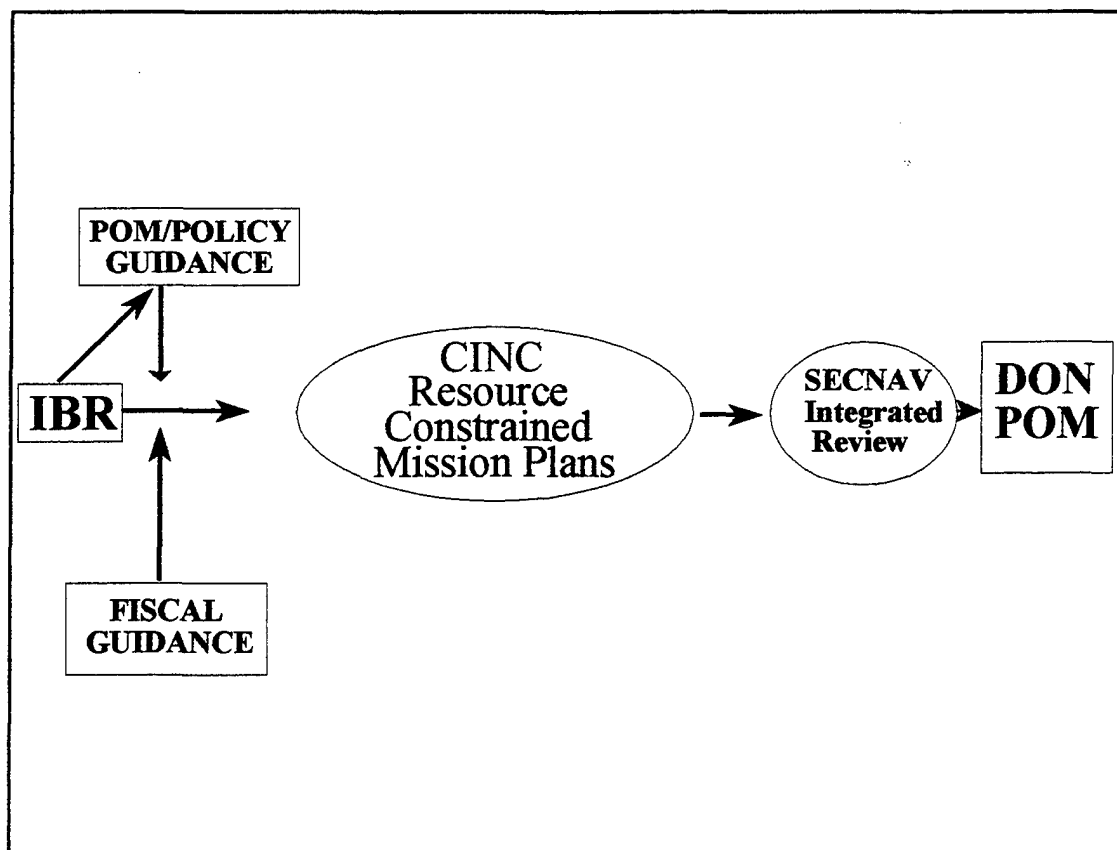

**Figure 23** Mission-Based Program Development

increased visibility, more refined program information, programs would have budget quality detail, and there would be far less need for “endgame” balancing. It would allow the CNO and SECNAV to focus on the big picture in a single format rather than at multiple points in the resource decision process. It would also highlight major resource tradeoffs for decision makers.

Mission budgeting could be implemented in other ways to reengineer Navy PPBS. The approach outlined here is illustrative of the types of thinking required to apply reengineering to make Navy resource decision-making both more efficient and effective.

## **D. GENERAL STAFF COMMAND**

### **1. Description**

Post WWII, Congress considered two alternatives for strategic planning and policy: (1) a corporate JCS made up of Service Chiefs and a chairman with a joint staff serving as a "reporting and analysis entity" to ensure the President receives a diversity of views, (2) a single, authoritarian chief of staff supported by a general staff. The Army favored military unification to promote the centralization of decision-making power; the Navy wanted a decentralized decision-making structure that retained Service autonomy and the coordination of policy through compromise (Ref. 49, p. 7). It was not without a hostile and bitter fight that the National Security Act of 1947 finally produced the JCS structure.

Today, perhaps the most radical approach for creating a more efficient resource allocation decision process within DOD would be establishment of a General Staff Command composed of a specially selected and trained cadre of career military officers. Such a group of officers specially trained in joint warfare and organized under an independent promotion system, would in theory be able, "to rise above Service interests," set unbiased military goals and priorities, and tailor the defense budget to achieve the most efficient allocation of funds. It may be argued that a General Staff would be able to provide fast, or more flexible decisions unencumbered by the parochial, self-serving interests of the Services. This is the ultimate form of "jointness."

Prior to passage of the Goldwater-Nichols Act, the JCS was required to provide military advice based on a consensus among the members. Because the members of JCS also represented a particular Service, i.e., the dual-hatted role of the Service Chiefs, they usually expressed their opinion in terms of what was best for their Service. The pressure was to build agreement and the result was a carefully drafted paper that accommodated everyone (Ref. 50, pp. 65-66).

Goldwater-Nichols significantly increased the powers of the Chairman, Joint Chiefs of Staff. The Chairman is now the principal military advisor to the National Command Authority (NCA). He no longer must reach a consensus among the Joint Chiefs before recommending options. He is also the transmitter of NCA decisions to the unified and specified combatant commanders. The Joint Staff now works directly for the Chairman. The individual services may review and provide comment on joint matters, but no longer must approve a particular position prior to its recommendation. (Ref. 10)

Goldwater-Nichols and previous legislation specifically protect against JCS operation as a General Staff: "The Joint Staff shall not operate or be organized as an Armed Forces General Staff and shall have no executive authority." (Refs. 10, 42, 43). However, implementation has taken the direction of "jointness" above all else. In fact, the increased role of JCS in resource issues has moved it from the primary task of strategic planning to competition in the budget battles, in effect, marrying requirements determination with resource allocation within the JCS.

While full implementation of a General Staff structure has not occurred, e.g., the Chairman must still present the advice or opinions of individual JCS members when those opinions differ from his and Service Chiefs still maintain Title X authority, the move has been unmistakably toward a de facto General Staff. This move is in recognition of the basic efficiencies of a General Staff:

- A cadre of professional officers trained and serving exclusively in the joint arena.
- Better, quicker decisions/advice to SECDEF and the President not rooted in Service parochialism.
- An objective view of CINC requirements from a purely Joint perspective.
- Better determination of the requirements of multi-service warfighting and coordination of the design specifications of those requirements, thereby conserving scarce fiscal resources (Ref. 51, p. 49).

## **2. Application to Navy POM and PPBS Processes**

Instituting a General Staff structure within the DOD would radically redesign the Navy POM and PPBS process. The exact process of implementing this type of structure is beyond the scope of this thesis but several major ramifications are evident.

Planning, already under the purview of the Joint staff, would take on an even greater role. Guidance emanating from JCS would be directive in nature, clearly identifying the roles, missions and capabilities that the Navy (and other Services) would perform. The Navy would concentrate on its "core competencies" [(carrier-based air and amphibious power projection, sea-based air and missile defense, and anti-submarine warfare) (Ref. 45, p. 2-20)]. Output

from the Joint Strategic Planning System (JSPS) would be prescriptive rather than descriptive of programs and budgets formulated by the Navy. The Joint Warfare Capabilities Assessment (JWCA) teams would make program decisions predicated on roles and functions of the Services in all joint areas: strike, ground maneuver, air superiority, overseas presence, etc.

The Navy would still retain the flexibility to determine the means to meet the directives of the General Staff. However, the end to incessant battling over roles and missions would simplify the process immensely. Most of the events in the program planning phase of the Navy POM could be eliminated. The JMA/SA assessments would be repetitious of the JWCA. Answers to questions of the Navy's future "size, structure and character" typically worked out in the JMA/SA assessments would be hashed out in a joint format where each Service's capabilities could be compared and the most prudent investments determined. Navy strategies to meet the dictates coming from the Joint Staff could be discussed in a limited JMA/SA that focused more on implementing recommendations than formulating them. Navy POM development would ensure that programs properly support Component Commander and Claimant requirements for executing Unified CINC missions.

The organizational trend of DOD since passage of the Goldwater-Nichols Act has been increasingly toward greater jointness. Whether this trend ultimately will lead to a General Staff Command structure is open to question and debate. Many fear that evolution to a General Staff Command would lead

logically to the merger of the three branches of the military into a single Service. Such fears tend to preclude consideration of the General Staff approach to reengineering PPBS.



## V. CONCLUSIONS/RECOMMENDATIONS

### A. CONCLUSIONS

Problems with the current PPBS process analyzed in this thesis may be summarized as follows:

- Process dominates substance. The process is so arduous that it consumes enormous scarce resources to execute, leaving little time for the participants to be thoughtful or creative.
- The strategy and planning aspects are weak and need to reflect "jointness" and greater CINC participation.
- The system was created pre-Goldwater-Nichols Act passage and fails to reflect the dramatic shift in responsibilities from the Departments to the JCS and CINCs, particularly in the requirements area.
- Few major decisions are made in the POM cycle. Rather, they are made in the budget cycle or via other processes such as the JROC, or in Congress.
- Considerable effort is expended thrashing out details of programs six years in the future while the uncertainties faced make major changes in six year plans almost certain. This inhibits flexibility and the ability to refocus programs as change occurs, and wastes a great deal of staff time and effort. (Ref. 52, p. 1)

Throughout the Departments of Defense and Navy there is a widespread belief that the PPBS process is broken beyond marginal fixes. The research completed for this thesis reinforces such skepticism. Changes that only a few years ago were considered radical are now being considered in the mainstream. A fundamental overhaul of the existing process appears to be necessary to bring defense resource allocation in line with the demands of the 21st Century. Why now? The high probability of even more severe budget constraints will require



the ability to operate effectively with less funding. Lessons learned from successful business initiatives appear to present the opportunity for substantial resource savings. Full implementation of the Goldwater-Nichols Act will continue the trend towards joint planning, budgeting and operations. The traditional "one-third split" and "who gets to do what" approach to defining roles and missions is being replaced by a "who needs what" approach to allocation decisions affecting joint military capabilities. A key issue is whether the CINCs have the set of capabilities they need to fulfill their missions. (Ref. 45, p. 1-4)

This thesis presented three frameworks for reengineering the Navy POM and PPBS processes: Strategy-to-Tasks, Mission-Based Resource Allocation, and the General Staff Command.

The Strategy-to-Tasks methodology provides only incremental improvements to the existing processes. It does not provide the radical process reengineering that is required. It still relies on the same centralized, bureaucratic process and traditional power players as the existing PPBS. While the Strategy-to-Tasks links provide a clearer, more rational process in defining requirements, it does not facilitate innovative ways to redefine them.

A mission-oriented approach to resource allocation would provide a fundamental change to the current PPBS process. A decentralized, mission-based process would improve the efficiency and effectiveness of DOD resource allocation by aligning resource allocation with mission purpose within the operating units, i.e., CINCs or Component Commanders. The operating units

are the "users" of the military capabilities while the Services compete to provide the required capabilities. Corporate experience shows the value of placing primary responsibility for resource allocation in the hands of those responsible for the "mission." It is within this structure that the efficiency and effectiveness of a joint fighting force is coupled with the innovation and creativity that interservice competition provides.

The apprehension of Congress and the American people with regard to a General Staff patterned after the Prussian-German model will likely prevent the complete unification of the U.S. Armed Services. The current system of Service autonomy reflects the American political system of checks and balances and the American economic system of competition. The development of options and alternatives for dealing with the wide array of threats facing the U.S. in a complex world depends upon the open airing of disagreements among the Services. The efficiency of a General Staff structure is rooted in its ability to suppress alternatives within its own organization. It insulates SECDEF and his staff from competing military points of view. The development of a variety of options, whether in resource allocation or military operations, requires the consideration of diverse and often conflicting viewpoints that arise from the protection of self-interests. It is the competition between the Services that provides the major impetus for innovation and creativity.

## **B. RECOMMENDATIONS**

It is the recommendation of this author that a mission-based system of resource allocation be further studied and debated with strong consideration toward implementation to reengineer PPBS. Implementation would require reengineering of the Navy POM and PPBS processes to provide required capabilities in response to CINC/Component Commander requirements.

Characteristics of the new mission-based system would include the following:

- Planning would be done at the JCS and OSD level. Programming and budgeting would be combined and performed largely, but not completely, at CINC/Component Commander level.
- Most of the defense budget would be allocated to CINCs/Component Commanders and the Services would compete to provide forces, weapons and supplies to the Unified Commands.
- PPBS would become more flexible to respond to changes in threat, technology or funding. It could enable roles, missions, functions and programs to respond to changes in the threat and political environments.
- PPBS would focus far more on mission outputs, outcomes and results rather than resource inputs.

In sum, the mission-based process would do four things which appear to be necessary. First, it would foster debate and consensus among major players on major issues at the beginning of the program development process, thus making programming and budgeting together less people and time consumptive, and far less complex and centralized than in the Pentagon. Second, it would allow participation of all the players, with a stronger role for CINCs, JCS and

military Service commanders. Third, it would put the decisions for matching more resources, requirements and capabilities where it belongs, with the operational users. Finally, it would streamline the decision process and make it more adaptive to change than the current program budgeting system.

### **C. AREAS FOR FURTHER RESEARCH**

This thesis provided a comprehensive description of the current PPBS process within the Department of the Navy. It also analyzed how the process could be reengineered utilizing three alternative methodological frameworks and recommended the mission-based approach.

Further research is necessary to provide alternative "blueprint designs" for implementation of the mission-based methodology in the Department of the Navy and DOD. The effects of implementation might not be limited to the organizational structure of DOD but could have broad implications for how Congress determines policy and budgets for national defense, and also for defense industry practices and DOD acquisition.



## APPENDIX A. GENERAL PPBS SCHEDULE

Date	Event	PPBS Phase
November	Draft Defense Guidance Issued	Planning
July-December	OPNAV warfare appraisals	Programming
October-March	CMC POM development	Programming
March	CNO Program and Fiscal Guidance issued	Programming
April	OPNAV Resource Sponsor Program Proposals submitted to N80	Programming
May	DON Program Strategy Board Review	Programming
April-May	DON budget guidance issued	Budgeting
Late May - early June	DON POM to OSD	Programming
Late May - early June	Controls issued for NAVCOMPT submission	Budgeting
Jun-Sept	OSD Program Review	Programming
Late July - Mid August	NAVCOMPT Budget Review	Budgeting
Mid - Late August	Program Decision Memorandum (PDM) issued	Programming
Late August	Secretary of the Navy decisions	Budgeting
Late August	Budget guidance and controls issue for OSD Submission	Budgeting
15 September	Budget to OSD/OMB	Budgeting
September-January	OSD/OMB Budget Review	Budgeting
Early-Mid January	Issue Controls and Budget Guidance for President's Budget	Budgeting
Early February	President's Budget to Congress	Budgeting
February-September	Congressional Review of Budget	Budgeting
1 October	Budget Execution begins	Budgeting



**Appendix B. POM-98 NAVY SCHEDULE OF EVENTS**

<b>Date</b>	<b>Events</b>	<b>Lead</b>	<b>Assist</b>	<b>Originating Mechanism</b>
Sep 95	Publish RAD VII/VIII (DON FY97) Budget Estimate Submission	N80	N82	Memo, Database
8 Dec 95	Unified CINCS submit Integrated Priority Lists	N83		OSD Message
Jul-Dec 95	DON Joint Mission Area/ Support (JMA/SA) Assessment Process	N81	Resource Sponsors	
5,6,7,8,11, 13,15, Dec 95	DON JMA/SA Assessment Briefs to Integrated R <sup>3</sup> B (IR <sup>3</sup> B)	N81/ USMC	Resource Sponsors	Briefing
Jan/Feb 96	Publish RAD IX/X FY 97 President's Budget	N80	N82	Database, Memo
17 Jan 96	3-Star Summary Brief of Assessments	N81		Briefing
19 & 20 Jan 96	CNO/CMC Summary Brief of Assessments	N81		Briefing
23 Jan 96	DPSB Summary Brief of Assessments	N81		Briefing
Feb 96	Component Commander Issue Paper submission	Comp. Commander	N83	Message/ POM-98 serial
Feb 96	Claimant Issues Submitted to Resource Sponsors	Claimants		POM serial
Feb 96	Baseline Assessment Memoranda due to N80	Various	N80	POM-98 Serial
21-22 Feb 96	DON Investment Balance Review (IBR) to IR <sup>3</sup> B	N81/ USMC		Briefing
Mar 96	Defense Planning Guidance (DPG) Issued	DOD		



<b>Date</b>	<b>Events</b>	<b>Lead</b>	<b>Assist</b>	<b>Originating Mechanism</b>
5 - 14 Mar 96	IBR Briefing to CINCS	N81/ USMC		Briefing
19 Mar 96	IBR Briefing to CEB	N81/ USMC		Briefing
20 Mar 96	IBR Briefing to ACMC Committee	N81/ USMC		Briefing
22 Mar 96	IBR Briefing to DPSB	N81/ USMC		Briefing
Mar 96	DON Programming Guidance Issued	SECNAV		Memo
Mar 96	Publish Preliminary Program Guidance for POM-98 -Detailed Programming guide -Fiscal Allocation to RSs	N80		POM-98 Serial
Mar-Apr 96	Build Sponsor Program Proposals (SPP)	RSs		Database
Apr 96	DOD Fiscal Guidance - Program Guidance Revised (If required)	DOD/ N80		POM-98 Serial
Apr-May 96	SPP Presentations to R <sup>3</sup> B & Backup Data Submission to N80 (SPPDs)	RSs		Brief, Memo
Apr 96	Database Available for Claimant Review	N80		Memo, Database
May 96	Post-SPP Assessments Submitted	Various RSs		Memo
May 96	Brief Tentative POM-98 (TPOM) to R <sup>3</sup> B	N80		Briefing
May 96	Brief TPOM-98 to R <sup>3</sup> B Executive Panel	N80		Briefing
May 96	Brief TPOM-98 to CNO/VCNO	N80		Briefing

Date	Events	Lead	Assist	Originating Mechanism
May 96	Brief POM-98 to DPSB	N80		Briefing
Jun 96	Final Balancing: Database Lock; Publish RAD XI/XII (POM-98)	N80		Database, Memo
Jun 96	Submit POM-98 Documentation to N80 per POM-98 Preparation Instructions (PPI)	N80		WordPerfect File Transfer
Jun 96	Submit POM-98 to OSD	N80		Database, Memo
Jun-Sept 96	OSD Summer Review	OSD	N80	



## LIST OF REFERENCES

1. Department of the Navy, *Force 2001: A Program Guide to the U.S. Navy*, Deputy Chief of Naval Operations (Resources, Warfare Requirements and Assessments), Washington, D.C. 1995.
2. U.S. Department of Defense, *Department of the Navy Planning, Programming and Budgeting System (PPBS)*. Secretary of the Navy Instruction 5000.16E, Washington D.C., 1986.
3. Babunakis, M., *Budgets: An Analytical and Procedural Handbook for Government and Non-Profit Organizations*, Greenwood Press, 1976.
4. Novick, D., *Current Practice in Program Budgeting (PPBS)*, Heinemann, 1973.
5. The Joint DOD/GAO Working Group on PPBS, *The Department of Defense's Planning, Programming and Budgeting System*, Washington D.C. 1983.
6. U.S. Department of Defense, *Practical Comptrollership Manual*, Monterey, CA., March 1996.
7. Department of the Navy, *PPBS Training Course*, Washington D.C. July, 1996.
8. Downey, Robert et al., *Building the Navy Program Objectives Memorandum: The Navy's Programming Process*, CIM 82 (Alexandria VA: Center for Naval Analyses, June 1990).
9. Olson, Christopher M., *A Comparison of Planning, Programming and Budgeting System (PPBS) Practices of the Military Departments*, Master's Thesis, Naval Postgraduate School, Monterey, CA.
10. *Goldwater-Nichols Department of Defense Reorganization Act of 1986*, Public Law 99-433 (100 Stat. 992-1000), 99th Congress.
11. Lewis, Leslie et al., *Analytic Architecture for Joint Staff Decision Support*, RAND's National Defense Research Institute, 1993.
12. Clinton, William J., *A National Security Strategy of Engagement and Enlargement*, The White House, February 1996.

13. Shalikashvili, John M., *National Military Strategy of the United States of America*, Chairman of the Joint Chiefs of Staff, 1995.
14. Defense Business Management University, *Planning, Programming, and Budgeting System (PPBS)*, Monterey, 1994.
15. U.S. Department of Defense, *Resources and Requirements Review Board*. Chief of Naval Operations Instruction 5420.2Q, Washington D.C., 26 January, 1993.
16. Grundman, Steven C., *Navy Resource Allocation Planning: New Ways to Think About Its Design and Management*, CRM 95-114 (Alexandria VA: Center for Naval Analyses, September 1995).
17. Keefe, John et al., *Assessment of the Assessment Process for Program Review 97*, CRM 95-117 (Alexandria VA: Center for Naval Analyses, August 1995).
18. U.S. Department of Defense, *Chief of Naval Operations (CNO) Executive Decision Process*. Chief of Naval Operations Instruction 5420.108, Washington D.C., 25 October, 1994.
19. U.S. Department of Defense, *Guidance for the Preparation, Submission and Review of the Department of the Navy (DON) Budget Estimates*. Navy Comptroller Instruction 7102.2C, 01 May, 1995.
20. U.S. Department of Defense, *Implementation of the Planning, Programming and Budgeting System (PPBS)*, Department of Defense Instruction 7045.7, Washington D.C., 23 May, 1984.
21. U.S. Department of Defense, Office of Chief of Naval Operations (N8), *PR-99 Department of the Navy Joint Mission Area/Support Area Assessments (Assessment Serial 99-01)*, Washington D.C., 17 September, 1996.
22. Department of the Navy, Office of the Chief of Naval Operations (N801), *Memorandum for the Distribution List, "Navy Programming Procedures for Program Objectives Memorandum (POM) -98,"* 16 November, 1995.
23. Department of the Navy, Office of the Chief of Naval Operations (N801), *POM-98 Sponsor Program Proposal Documents (SPPDs) For Component Commander Issue Papers (CIPs)*, Washington, D.C., 11 March, 1996.

24. Department of the Navy, Office of the Chief of Naval Operations (N801), *Sponsor Program Proposal (SPP) Presentations For POM-98*, Washington, D.C., 13 March 1996.
25. Blaker, James R., *The Joint Mission Area Assessment Process*, CRM 93-25 (Alexandria, VA: Center for Naval Analysis), February 1994.
26. Department of the Navy, Office of the Chief of Naval Operations (N801), *Programming and Fiscal Guidance for POM-98*, Washington, D.C., 18 March, 1996.
27. U.S. Department of Defense, Department of the Navy Program Information Center, *Instructions For the FY 1998-2003 OSD Program Review-Action Memorandum*, Washington, D.C., 01 May, 1996.
28. Hammer, Michael, *Reengineering Work: Don't Automate, Obliterate*, Harvard Business Review, Summer, 1990.
29. Hammer, M. and Steven A. Stanton, *The Reengineering Revolution: A Handbook*, HarperCollins, 1995.
30. Champy, J. and M. Hammer, *Reengineering the Corporation: A Manifesto for Business Revolution*, HarperCollins, 1993.
31. Davenport, T. H. *Process Innovation: Reengineering Work Through Information Technology*, Harvard Business School Press, 1993.
32. AT&T, *Reengineering Handbook*, Indianapolis: Customer Information Center, Select Code 500-449, 1991.
33. Bryson, John M., *Strategic Planning for Public and Nonprofit Organizations*, Josey-Bass Inc, 1995.
34. Fletcher, Tom. *Reengineering Government*, Governing Magazine, February, 1994.
35. Shoop, Tom. *Reinventing Government*, Government Executive, September 1994.
36. Reimer, General Dennis J. *Reengineering Forces Command for the 21st Century*, Army, May 1995.

37. U.S. Department of Defense, *Functional Process Improvement*, Department of Defense Instruction 8020.10-M, Washington D.C., 1992.
38. D. Appleton Company. *Corporate Information Management: Process Improvement Methodology For DOD Managers*, Fairfax, VA., 1993.
39. Davis, Robert J., *Framework For Managing Process Improvement: A Guide to the Methodology*, Assistant Secretary of Defense (Command, Control, Communications, and Intelligence), Washington, D.C., 1994.
40. *The National Security Act of 1947*, Public Law 253 (61 Stat. 758).
41. Thompson, Fred and Jones, L.R., *Reinventing the Pentagon How the New Public Management Can Bring Institutional Renewal*, Jossey-Bass Inc., 1994.
42. *National Security Act Amendments of 1949*, Public Law 216.
43. *Department of Defense Reorganization Act of 1958*, Public Law 85-599 (85th Congress).
44. *National Defense Authorization Act for Fiscal Year 1994*, Public Law 103-160, 30 November, 1993 (as amended).
45. U.S. Department of Defense, *Report of the Commission on Roles and Missions of the Armed Forces*, 24 May, 1995.
46. Lewis, Leslie and C. Robert Roll, *Strategy-to-Tasks: A Methodology for Resource Allocation and Management*, RAND, September 1993.
47. Jones, L.R. and Glenn C. Bixler, *Mission Financing to Realign National Defense*, Jai Press Inc., 1992.
48. Yung, C. D., and Lisa H. Saladino, *Incorporating Joint Perspectives in the Navy's Assessment Process*, CRM 93-24 (Alexandria, VA: Center for Naval Analysis), August 1993.
49. Seeley, Mark T., *The Goldwater-Nichols Department of Defense Act of 1986: Genesis and Postscript*, Master's Thesis, Naval Postgraduate School, Monterey, CA. 1987.
50. Jones, GEN David C., *Why the Joint Chiefs of Staff Must Change*, Armed Forces Institute, March, 1982.

51. Moses, Louis J., *The Call for JCS Reform*, Washington, D.C., 1985.
52. Odeen, Phil, *A New Resource Allocation Planning System*, BDM Memorandum to Admiral Bill Owens, 11 October, 1994.





## INITIAL DISTRIBUTION LIST

1. Defense Technical Information Center ..... 2  
8725 John J. Kingman Rd., STE 0944  
Ft. Belvoir, VA 22060-6218
2. Dudley Knox Library ..... 2  
Naval Postgraduate School  
411 Dyer Rd.  
Monterey, CA 93943-5101
3. Dr. L. R. Jones, Code SM/JN ..... 2  
Naval Postgraduate School  
Monterey, CA 93943-5000
4. Dr. Jerry L. McCaffery, Code SM/MM ..... 1  
Naval Postgraduate School  
Monterey, CA 93943-5000
5. LT Thomas A. Simcik ..... 1  
252 Colonial Dr.  
Pittsburgh, PA 15216
6. Comptroller ..... 2  
COMNAVAIRPAC (Code 019)  
NAS North Island  
P. O. Box 357051  
San Diego, CA 92135-7051
7. Mr. Michael L. Dominguez ..... 1  
Associate Director for Programming (N80D)  
2000 Navy Pentagon  
Washington, D.C. 20350-2000
8. Mr. Robert L. Panek ..... 1  
Director, Office of Budget (N82B)  
1100 Navy Pentagon  
Washington, D.C. 20350-1100
9. CAPT Michael W. Casey ..... 1  
Commander  
Defense Distribution Region West  
P.O. Box 960001  
Stockton, CA 95296-0002